



**RICAMBI
RIMORCHI**



**RICAMBI, COMPONENTI E ACCESSORI
PER RIMORCHI E CARAVAN**

www.agmricambi.it

INDICE

ASSALI E SEMIASSI	PAG. 5	RUOTINI/SUPPORTI/COPERTURE	
IMPIANTO FRENANTE	PAG. 9	RUOTINI D'APPOGGIO E SUPPORTI	PAG. 80
AMMORTIZZATORI E PARAFANGHI	PAG. 45	COPERTURE DI PROTEZIONE	PAG. 83
RUOTE COMPLETE/CERCHI	PAG. 51		
TIMONI/REPULSORI	PAG. 55		
RUOTINI/SUPPORTI/COPERTURE	PAG. 79		
FANALERIA	PAG. 85	FANALERIA	
CHIUSURE/CERNIERE	PAG. 111	GIROFARI A LED	PAG. 86
IDENTIFICAZIONE ASSALI	PAG. 117	FANALI POSTERIORI LED	PAG. 86
IDENTIFICAZIONE REPULSORI	PAG. 118	FANALI DI INGOMBRO LED	PAG. 87
CONDIZIONI GENERALI DI VENDITA	PAG. 119	FANALI DI POSIZIONE LATERALI LED	PAG. 88
		FANALI POSTERIORI CONNESSIONE CON FILO	PAG. 90
		FANALI POSTERIORI CON CONNETTORI	PAG. 92
		KIT LUCI - BARRE REGOLABILI	PAG. 96
		VETROFANALI	PAG. 97
		FANALI DI INGOMBRO	PAG. 100
		FANALI DI POSIZIONE LATERALI	PAG. 101
		FANALI DI POSIZIONE ANTERIORI	PAG. 102
		FANALI LUCE TARGA / LAMPADINE	PAG. 103
		CATADIOTTRI	PAG. 104
		DISCO LIMITE DI VELOCITA'	PAG. 105
		LETTERE E NUMERI ADESIVI	PAG. 105
		CABLAGGI/PROLUNGHE	PAG. 106
		PRESE/SPINE/ADATTATORI	PAG. 107
		CHIUSURE/CERNIERE	
		CHIUSURE/CERNIERE	PAG. 112
		CAPPUCCI TERMINALI	PAG. 116
		IDENTIFICAZIONE ASSALI	PAG. 117
		IDENTIFICAZIONE REPULSORI	PAG. 118
		CONDIZIONI GENERALI DI VENDITA	PAG. 119
IMPIANTO FRENANTE			
KIT CEPPI FRENO	PAG. 10		
TAMBURI FRENO	PAG. 16		
MASSE FRENO	PAG. 22		
FRENO COMPLETO	PAG. 23		
PORTA CEPPI	PAG. 25		
FUSELLI	PAG. 26		
LEVE SPREITZ/DISP. AP. CEPPI	PAG. 27		
REGISTRI FRENO	PAG. 29		
KIT CUSCINETTI	PAG. 30		
CUSCINETTI COMPACT	PAG. 32		
CUSCINETTI E PARAOLI	PAG. 33		
DADI E RONDELLE MOZZO	PAG. 36		
COLONNETTE/COPRIMOZZO	PAG. 37		
CAVI FRENO A MANO	PAG. 39		
ACCESSORI CAVI FRENO A MANO	PAG. 42		
AMMORTIZZATORI E PARAFANGHI			
AMMORTIZZATORI	PAG. 46		
PARAFANGHI	PAG. 48		
RUOTE COMPLETE/CERCHI			
CERCHI/DISCHI RUOTA	PAG. 52		
RUOTE COMPLETE	PAG. 53		
PORTARUOTA DI SCORTA	PAG. 53		
CUNEO FERMA RUOTA C/SUPPORTO	PAG. 53		
TIMONI/REPULSORI			
GIUNTI A SFERA	PAG. 56		
STABILIZZATORI	PAG. 60		
SFERE PER GIUNTI	PAG. 61		
ANTIFURTI	PAG. 62		
AMM. REPULSORI/TIMONI	PAG. 64		
ALBERINI	PAG. 69		
BOCCOLE TIMONE	PAG. 70		
SOFFIETTI/CUFFIE	PAG. 72		
LEVE FRENO A MANO	PAG. 74		
FUNI DI SICUREZZA	PAG. 77		

ASSALI



ATTACCHI RUOTA

58x98/4-M12

66x112/5-M12

93X140/5-M14

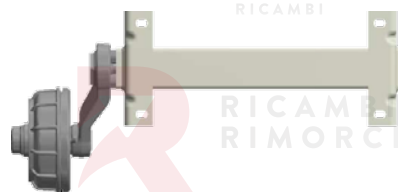
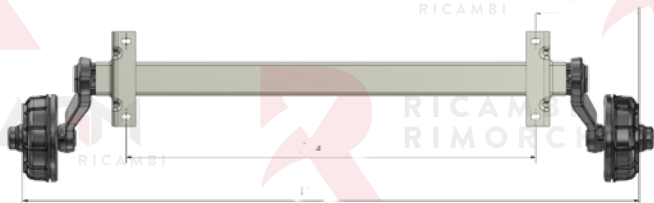

ASSALI FRENATI STANDARD

PORTATA KG.	FRENO	A mm.	B mm.
450	135X30	770	1070
450	135X30	900	1330
450	135X30	950	1350
750	160X35	390	1020
1000	160X35	290	1030
1500	200X50	540	1300
1800	250X40	450	1320
2500	250X60	880	1520
3500	305X80	880	1520

SEMIASSI FRENATI STANDARD

PORTATA KG.	FRENO	B mm.
375	160X35	520
500	160X35	530
750	200X50	660
900	250X40	670
1200	250X60	770
1750	305X80	770

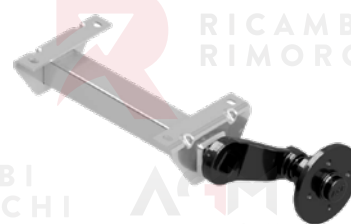

ASSALI NON FRENATI STANDARD

PORTATA KG.	A mm.	B mm.
900	280	1020

SEMIASSI NON FRENATI STANDARD

PORTATA KG.	B mm.
450	520

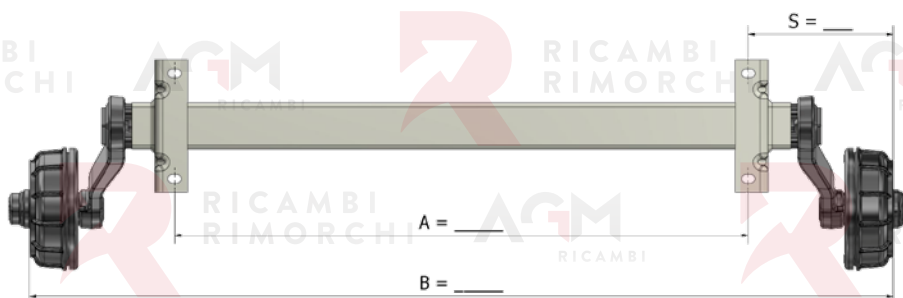

ORDINARE UN ASSE

Per identificare il tipo di assale dovrete indicare i seguenti dati:

- Frenato o non frenato
- Portata kg.
- Attacco ruota
- Interasse staffe, quota "A"
- Carreggiata, quota "B"
- Asse singolo o due assali (tandem)

IMPIANTO FRENANTE



AL-KO



AGM 50261735 - AL-KO 10261255

AL-KO 135.30 - 1220335

DIM. TAMBURO 135X30



AGM 50261736 - AL-KO 10261256

AL-KO 1635/1636/1637 - 1213888

DIM. TAMBURO 160X35



AGM 50262040 - AL-KO 10262525

AL-KO 1640

DIM. TAMBURO 160X40

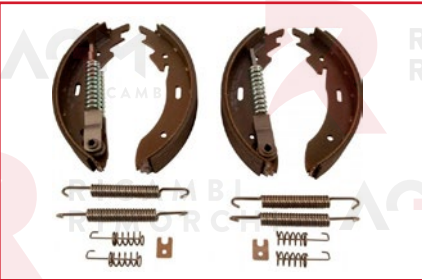

AGM 50262095

AL-KO 2035 SR 201/202/203

DIM. TAMBURO 200X35



AGM 50262096

AL-KO SB 200

DIM. TAMBURO 200X35

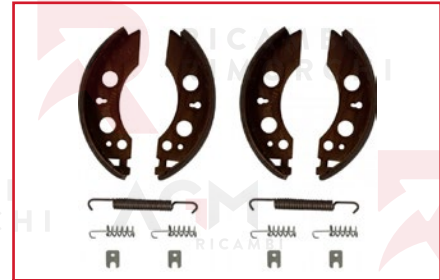

AGM 50261737

AL-KO 2035 - 1220328

DIM. TAMBURO 200X35



AGM 50261738 - AL-KO 10261258

AL-KO 2050/2051 - 1213889

DIM. TAMBURO 200X50



AGM 10261978

AL-KO 2051 AAA - 1730057

DIM. TAMBURO 200X50



AGM 50262097

AL-KO SR 230

DIM. TAMBURO 230X40



AGM 50261979

AL-KO 2350 - 1220329

DIM. TAMBURO 230X50

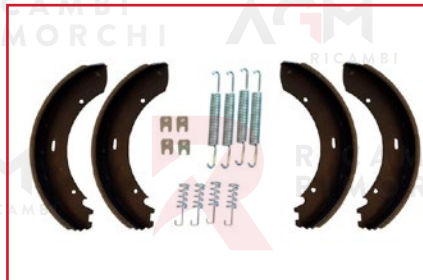

AGM 50262098

AL-KO SB 230

DIM. TAMBURO 230X60



AGM 50261739 - AL-KO 10261259

AL-KO 2360/2361 - 1213890

DIM. TAMBURO 230X60



AL-KO 10262526
AL-KO 2361 AAA
 DIM. TAMBURO 230X60



AL-KO 10262392
AL-KO 1635/1636/1637
 DIM. TAMBURO 160X35



AGM 50262041 - AL-KO 10262393
AL-KO 2050/2051
 DIM. TAMBURO 200X50



AGM 50262403
AL-KO MOLLA PER 1637
AGM 50262404
AL-KO MOLLA PER 2035/2050/2051/2350/2351



AGM 11262042
BPW S 1704-7 RASK
 DIM. TAMBURO 170x40



AGM 11262100
BPW S 2035-7 RASK
 DIM. TAMBURO 200X35



AGM 11261260
BPW S 2005-7 RASK
 DIM. TAMBURO 200X50



AGM 11261261
BPW S 2304-7 RASK
 DIM. TAMBURO 230X40



AGM 11262101
BPW S 2304-2 RASK
 DIM. TAMBURO 230X40



AGM 11261262
BPW S 2504-7 RASK
 DIM. TAMBURO 250X40



AGM 11262110
BPW S 2504-SK
 DIM. TAMBURO 250X40

ELLEBI

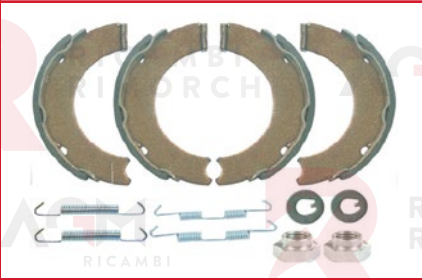

AGM 50261263 - ELLEBI 14261720

ELLEBI 135.30 FISSO - 901899001

DIM. TAMBURO 135X30



AGM 14261719 - ELLEBI 13261896

ELLEBI 135.30 AR - 901899002

DIM. TAMBURO 135X30

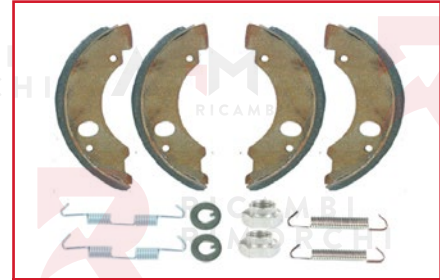

AGM 13261265

ELLEBI 150 - 901899003

DIM. TAMBURO 151X35

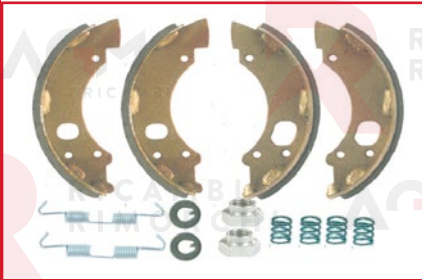

AGM 13261266

ELLEBI 151 - 901899004

DIM. TAMBURO 151X35

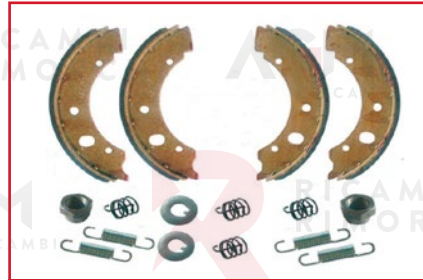

AGM 13261267

ELLEBI 185 - 901899005

DIM. TAMBURO 186X35



AGM 13261268

ELLEBI 186 - 901899006

DIM. TAMBURO 186X35

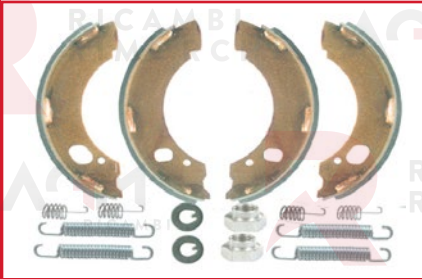

AGM 13261269

ELLEBI 220 - 901899007

DIM. TAMBURO 221x50

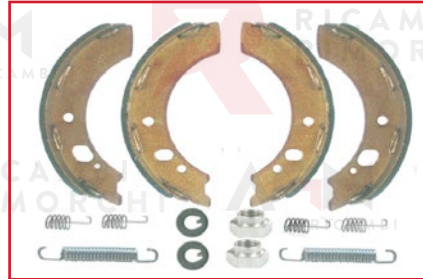

AGM 13261270

ELLEBI 221 - 901899008

DIM. TAMBURO 221X50



AGM 50261275

ELLEBI 16 1365 - 30781

DIM. TAMBURO 160X35



AGM 50261277

ELLEBI 20 2425/1 - 30780

DIM. TAMBURO 200X50



AGM 50261279

ELLEBI 25 2025 - 30783

DIM. TAMBURO 250X40

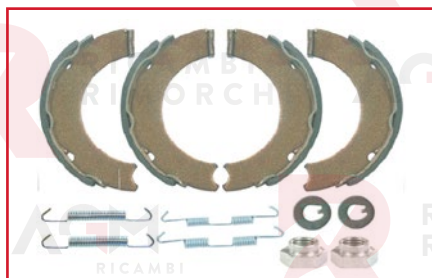

AGM 50261263

GSM 135.30 FISSO

DIM. TAMBURO 135X30



AGM 14261719

GSM 135.30 AR

DIM. TAMBURO 135X30

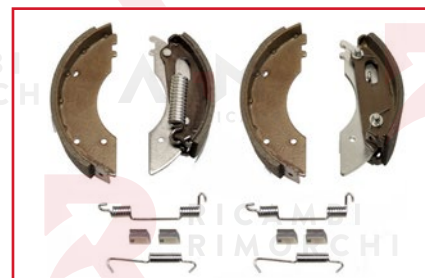

AGM 50261271

GSM/GKN/FAD 160.35

DIM. TAMBURO 160X35

GSM



AGM 50261272

GSM/GKN/FAD 200.35

DIM. TAMBURO 200X35



AGM 50261273

GSM/GKN/FAD 200X50

DIM. TAMBURO 200X50

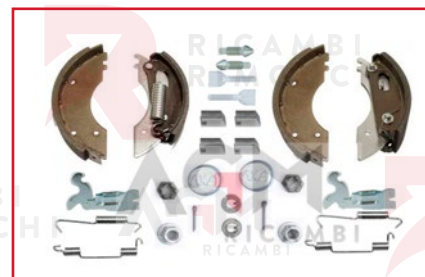

AGM 14261721

GSM/GKN/FAD 160.35

DIM. TAMBURO 160X35

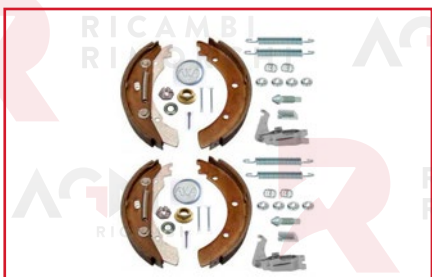

AGM 14261722

GSM/GKN/FAD 200.35

DIM. TAMBURO 200X35

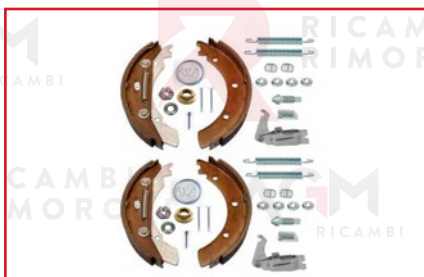

AGM 14261723

GSM/GKN/FAD 200X50

DIM. TAMBURO 200X50



AGM 14261274

GSM/GKN/FAD 250X40

DIM. TAMBURO 250X40

KNOTT / PEITZ / WAP

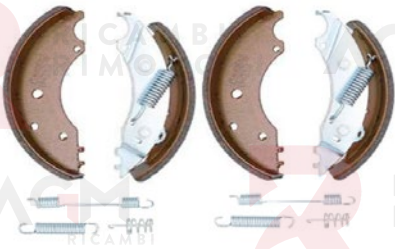

AGM 50262111

KNOTT 16 1365

DIM. TAMBURO 160X35

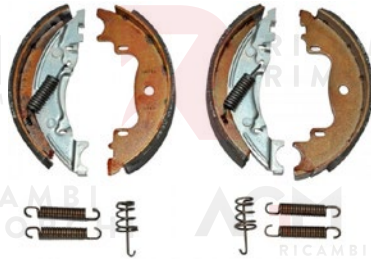

AGM 50261275

KNOTT 16 1365

DIM. TAMBURO 160X35



AGM 50261276

KNOTT 20963/1

DIM. TAMBURO 200X30



AGM 50261277

KNOTT 20 2425/1

DIM. TAMBURO 200X50



AGM 50261278

KNOTT 20,32-1647

DIM. TAMBURO 203,2X40



AGM 50261279

KNOTT 25 2025

DIM. TAMBURO 250X40

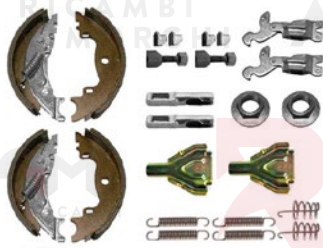

KNOTT 12262395

KNOTT 16-1365

DIM. TAMBURO 160X35

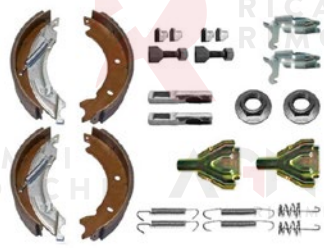

AGM 50262119

KNOTT 20-2425/1

DIM. TAMBURO 200X50



AGM 50262102

PEITZ R 234-76

DIM. TAMBURO 230X40



AGM 50262103

PEITZ S 234 R

DIM. TAMBURO 230X40

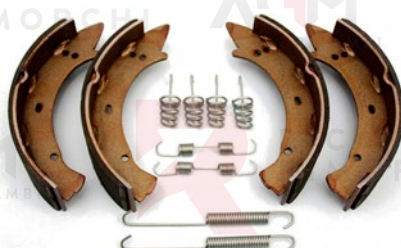

AGM 50262108

WAP W 205 RS

DIM. TAMBURO 200x50



AGM 50262109

WAP W 235 RS

DIM. TAMBURO 230x50



AGM 50262409 - OMC 16261280

OMC 135.30 IT

DIM. TAMBURO 135X30



AGM 50262106 - OMC 16261281

OMC 135.30 AR

DIM. TAMBURO 135X30



AGM 50262107 - OMC 16261282

OMC 160.35

DIM. TAMBURO 160X35



AGM 16261283

OMC 160.40

DIM. TAMBURO 160X40



AGM 16261284

OMC 200.35

DIM. TAMBURO 200X35



AGM 16261285

OMC 200.50

DIM. TAMBURO 200X50



AGM 16261286

OMC 200.60

DIM. TAMBURO 200X60



AGM 16261287

OMC 230.40

DIM. TAMBURO 230X40



AGM 16261288

OMC 230.60

DIM. TAMBURO 230X60

AL-KO



AGM 10321313

AL-KO 135.30 (370799)

FORATURA 4x98

DIM. TAMBURO 135X30



AGM 10321314

AL-KO SB/SR/160/1635 (691472)

FORATURA 4x98

DIM. TAMBURO 160X35



AGM 10321315

AL-KO 1636/1637 (691474)

FORATURA 4x98

DIM. TAMBURO 160X35



AGM 10322007

AL-KO EURO 1636 (1368398)

FORATURA 4x98

DIM. TAMBURO 160X35



AGM 10321316

AL-KO 2035/2050/2051 (691492)

FORATURA 4x98

DIM. TAMBURO 200X50



AGM 10321317

AL-KO COMPACT 1637 (623748)

FORATURA 4x98

DIM. TAMBURO 160X35



AGM 10321318

AL-KO EURO 1637 (573188)

FORATURA 4x98

DIM. TAMBURO 160X35



AGM 10321319

AL-KO COMPACT 2051Aa (623111)

FORATURA 4x98

DIM. TAMBURO 200X50



AGM 10321320

AL-KO EURO 2051Aa-Bb (573191)

FORATURA 4x98

DIM. TAMBURO 200X50



AGM 10322038

AL-KO 1636/1637 (357701)

FORATURA 100x4

DIM. TAMBURO 160X35



AGM 10322113

AL-KO 1636/1637 (372413)

FORATURA 5x112

DIM. TAMBURO 160X35



AGM 10321321

AL-KO COMPACT 1636/1637 (623749)

FORATURA 4x100

DIM. TAMBURO 160X35



AGM 10321322

AL-KO COMPACT 1637 (623750)

FORATURA 5x112

DIM. TAMBURO 160X35



AGM 10321323

AL-KO 2035/2050 (691488 EX 357706)

FORATURA 4x100

DIM. TAMBURO 200X50



AGM 10321324

AL-KO 2035/2050/2051 (691489 EX 357708)

FORATURA 5x112

DIM. TAMBURO 200X50



AGM 10321325

AL-KO EURO 2051 (573192)

FORATURA 4x100

DIM. TAMBURO 200X50



AGM 10321326

AL-KO COMPACT 2051 (623112)

FORATURA 4x100

DIM. TAMBURO 200X50



AGM 10321327

AL-KO COMPACT 2051 (586450)

FORATURA 5x112

DIM. TAMBURO 200X50



AGM 10321328

AL-KO EURO 2051 (573193)

FORATURA 5x112

DIM. TAMBURO 200X50



AGM 10321329

AL-KO COMPACT 2051 (623113)

FORATURA 5x112

DIM. TAMBURO 200X50



AGM 10321330

AL-KO EURO 2360/2361 (573194)

FORATURA 5x112

DIM. TAMBURO 230X60



AGM 10321331

AL-KO EURO 2360/2361 (1337624 EX 371843) WATERPROOF

FORATURA 5x112

DIM. TAMBURO 230X60

AL-KO

BPW / ELLEBI / GSM



AGM 11322115

BPW 379 S 2005-5

FORATURA 5x112

DIM. TAMBURO 200X50



AGM 11322116

BPW 316/358/362 S 2005-7

FORATURA 5x112

DIM. TAMBURO 200X50



AGM 11322117

BPW ECO 379 S 2005-7

FORATURA 5x112

DIM. TAMBURO 200X50



AGM 13321332

ELLEBI KIT MFR 150/151

IL KIT COMPRENDE:
TAMBURO, CUSCINETTI, PARAOLIO, DADO
MOZZO, RONDELLA, COPRIMOZZO



AGM 13321333

ELLEBI KIT MFR 185/186

IL KIT COMPRENDE:
TAMBURO, CUSCINETTI, PARAOLIO, DADO
MOZZO, RONDELLA, COPRIMOZZO



AGM 13321334

ELLEBI KIT MFR 220/221

IL KIT COMPRENDE:
TAMBURO, CUSCINETTI, PARAOLIO, DADO
MOZZO, RONDELLA, COPRIMOZZO



AGM 14321335

AXF/GSM KIT 135.30

FORATURA 4x98

DIM. TAMBURO 135X30



AGM 14321336

**AXF/GSM KIT 160X35 CUSCINETTI R.C.
COMPLETO DI COPRIMOZZO E COLONNETTE**

FORATURA 4x98

DIM. TAMBURO 160X35



AGM 14321338

**AXF/GSM KIT 160X35 COMPACT
COMPLETO DI COPRIMOZZO E COLONNETTE**

FORATURA 4x98

DIM. TAMBURO 160X35



AGM 14321337

**AXF/GSM KIT 200X35 CUSCINETTI R.C.
COMPLETO DI COPRIMOZZO E COLONNETTE**

FORATURA 4x98

DIM. TAMBURO 200X35



AGM 14321342

**AXF/GSM KIT 200X50 CUSCINETTI R.C.
COMPLETO DI COPRIMOZZO E COLONNETTE**

FORATURA 4x98

DIM. TAMBURO 200X50



AGM 14321987

**AXF/GSM KIT 200X50 COMPACT
COMPLETO DI COPRIMOZZO E COLONNETTE**

FORATURA 4x98

DIM. TAMBURO 200X50



AGM 14321339

**AXF/GSM KIT 200X50 CUSCINETTI R.C.
COMPLETO DI COPRIMOZZO E COLONNETTE**

FORATURA 5x112

DIM. TAMBURO 200X50



AGM 14322123

**AXF/GSM KIT 200X50 COMPACT
COMPLETO DI COPRIMOZZO E COLONNETTE**

FORATURA 5X112

DIM. TAMBURO 200X50



AGM 14321340

**AXF/GSM KIT 200X50 CUSCINETTI R.C.
COMPLETO DI COPRIMOZZO E COLONNETTE**

FORATURA 5X140

DIM. TAMBURO 200X50

GSM



AGM 14322124

**AXF/GSM KIT 200X50 COMPACT
COMPLETO DI COPRIMOZZO E COLONNETTE**

FORATURA 5X140

DIM. TAMBURO 200X50



AGM 14321343

**AXF/GSM KIT 250X40 CUSCINETTI R.C.
COMPLETO DI COPRIMOZZO E COLONNETTE**

FORATURA 5X140

DIM. TAMBURO 250X40

KNOTT



AGM 12321346

KNOTT 16/1365 COMPACT

FORATURA 4x100
DIM. TAMBURO 160X35 H 90



AGM 12322410

KNOTT 16/1365 COMPACT

FORATURA 4x100 (CUSC. STAGNO)
DIM. TAMBURO 160X35 H 90



AGM 12322120

KNOTT 16/1365 COMPACT

FORATURA 5x112
DIM. TAMBURO 160X35 H 90



AGM 12322121

KNOTT 16/1365 COMPACT

FORATURA 5x112 (CUSC. STAGNO)
DIM. TAMBURO 160X35 H 90



AGM 12321347

KNOTT 20/2425-1

FORATURA 4x100
DIM. TAMBURO 200X50

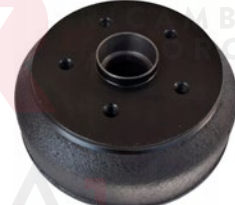

AGM 12321348

KNOTT 20/2425-1

FORATURA 5x112
DIM. TAMBURO 200X50



AGM 12321349

KNOTT 20/2425-1 COMPACT

FORATURA 4x100
DIM. TAMBURO 200X50 H 83



AGM 12321350 - AGM 12322406

KNOTT 20/2425-1

FORATURA 5x112
DIM. TAMBURO 200X50 H 83

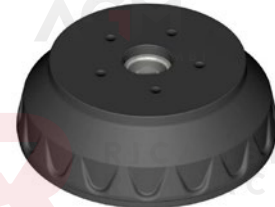

AGM 12322122

KNOTT 25/2025 COMPACT

FORATURA 5x112
DIM. TAMBURO 250X40 H 98



AGM 16321351

OMC 135.30

FORATURA 4x98

DIM. TAMBURO 135X30



AGM 16321352

OMC 160.35/160.40/164 AR

FORATURA 4x98

DIM. TAMBURO 160X35



AGM 16322125

OMC 160.35/160.40/164 AR

FORATURA 4x100

DIM. TAMBURO 160X35



AGM 16321353

OMC 200.50

FORATURA 4x98

DIM. TAMBURO 200X50



AGM 16322126

OMC 200.50

FORATURA 4x100

DIM. TAMBURO 200X50



AGM 16322127

OMC 200.50

FORATURA 5x112

DIM. TAMBURO 200X50



AGM 16321354

OMC 200.60

FORATURA 5x112

DIM. TAMBURO 200X60

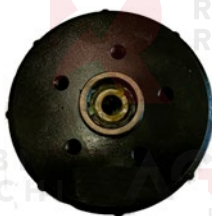

AGM 16322130

**OMC 230.40
PER RUOTA GEMELLARE**

FORATURA 5x112

DIM. TAMBURO 230X40



AGM 16322131

OMC 230.60

FORATURA 5x112

DIM. TAMBURO 230X60



AGM 16322132

OMC 230.60

FORATURA 5X140

DIM. TAMBURO 230X60

OMC

AAA PREMIUM BRAKE IL FRENO AD ALTA PRESTAZIONE

AL-KO
QUALITY FOR LIFE

Adatti per i freni ruota AL-KO e quindi per la maggior parte dei rimorchi con assali AL-KO.

I consolidati freni ruote AL-KO (con valori di frenata superiori alla media) sono integrati con la funzione di regolazione automatica.

In retromarcia l'autoregolazione viene disattivata per impedire il bloccaggio del freno.

Facile passaggio alla tecnologia più recente grazie al sistema pre-montato (sistema avvitabile AL-KO)

I freni AAA si regolano automaticamente in caso di gioco eccessivo. In tal modo, l'impianto frenate è sempre ottimamente regolato, consentendo di ridurre lo spazio di arresto nelle situazioni pericolose.

Guida più sicura grazie a uno spazio d'arresto ridotto fino a 5 metri.

Maggiore comfort di guida grazie a frenate morbide senza scatti.

Minori costi di manutenzione. Nessuna necessità del primo service in officina dopo 1.000 km

Non richiede aggiornamenti omologativi.



AGM 10262394

AL-KO 2051 AAA

VERS. CON DENTI DI FISS. A 4 FORI



AGM 10262365

AL-KO 2051 AAA

VERS. CON DENTI DI FISS.



AGM 10262347

AL-KO 2361 AAA

VERS. CON DENTI DI FISS. A 4 FORI



AGM 10262348

AL-KO 2361 AAA

VERS. CON DENTI DI FISS.

FRENO COMPLETO



AGM 13331355

ELLEBI FRENO 150 LB SX/DX - 498550030

CAVO GUAINA L. 1100



AGM 13332356

ELLEBI FRENO 150 LB SX/DX - 498550003

CAVO GUAINA L. 1350



AGM 13331356

ELLEBI FRENO DX 151 LB - 498510102

CAVO GUAINA L. 1100



AGM 13331357

ELLEBI FRENO SX 151 LB - 498510103

CAVO GUAINA L. 1100



AGM 13331358

ELLEBI FRENO 185 11" LB DX/SX - 498520033

CAVO GUAINA L. 1100



AGM 13331359

ELLEBI FRENO DX 186 LB - 498520352

CAVO GUAINA L. 1100



AGM 13331360

ELLEBI FRENO SX 186 LB - 498520353

CAVO GUAINA L. 1100



AGM 13331361

ELLEBI FRENO DX 221 LB - 498015260

CAVO GUAINA L. 1100



AGM 13331362

ELLEBI FRENO SX 221 LB - 498015261

CAVO GUAINA L. 1100

ELLEBI / GSM / OMC



AGM 14332171

AXF/GSM 200X50 DX 750 COMPACT

DIM. TAMB. 200x50 - 4x98



AGM 14332172

AXF/GSM 200X50 SX 750 COMPACT

DIM. TAMB. 200x50 - 4x98



AGM 14332173

AXF/GSM 250X40 DX

DIM. TAMB. 250x40 - 5x140



AGM 14332174

AXF/GSM 250X40 SX

DIM. TAMB. 250x40 - 5x140



AGM 16331363

OMC 135.30 DX

DIM. TAMB. 135x30 - 4x98



AGM 16331364

OMC 135.30 SX

DIM. TAMB. 135x30 - 4x98



AGM 16331365

OMC 160.35 DX

DIM. TAMB. 160x35 - 4x98



AGM 16331996

OMC 160.35 SX

DIM. TAMB. 160x35 - 4x98



AGM 16331366

OMC 160.40 DX

DIM. TAMB. 160x40 - 4x98



AGM 16331367

OMC 160.40 SX

DIM. TAMB. 160x40 - 4x98

RICAMBI

RICAMBI

RICAMBI

AL-KO / ELLEBI



AGM 10272133

AL-KO 1637 SX - 1362874

DIM. TAMBURO: 160x35



AGM 10272134

AL-KO 1637 DX - 1362875

DIM. TAMBURO: 160x35



AGM 10272135

AL-KO 2051 SX - 692560

DIM. TAMBURO: 200x50



AGM 10272136

AL-KO 2051 DX - 692561

DIM. TAMBURO: 200x50



AGM 10272137

AL-KO 2361 SX - 692566

DIM. TAMBURO: 230x60



AGM 10272138

AL-KO 2361 DX - 692567

DIM. TAMBURO: 230x60



AGM 13271289

ELLEBI 150

ELLEBI 498510048



AGM 13271290

ELLEBI 151/A

ELLEBI 498510106



AGM 13271291

ELLEBI 185

ELLEBI 498520012



AGM 13271292

ELLEBI 186/A

ELLEBI 498520360



AGM 13271293

ELLEBI 221/A

ELLEBI 498015110

RICAMBI
RIMORCHI

RICAMBI

RICAMBI
RIMORCHI

AGM
RICAMBI

AL-KO / ELLEBI

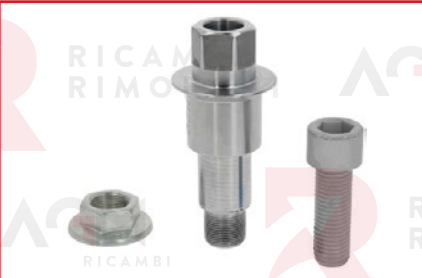

AGM 10282142

AL-KO FRENO 1637 COMPACT - 605566



AGM 10282143

AL-KO FRENO 1637 EURO - 581563



AGM 10282144

AL-KO FRENO 2051 COMPACT Aa
605119



AGM 10282145

AL-KO FRENO 2051 COMPACT Ab
605495

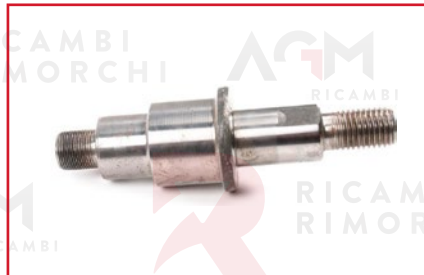

AGM 10282146

AL-KO FRENO 2051 EURO Aa/Bb
581043



AGM 10282147

AL-KO FRENO 2361 EURO - 582541

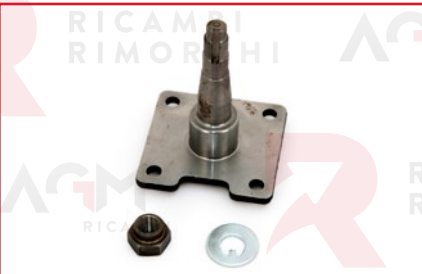

AGM 13281294

ELLEBI FRENO 135 + DADO E RONDELLA

ELLEBI 299350024

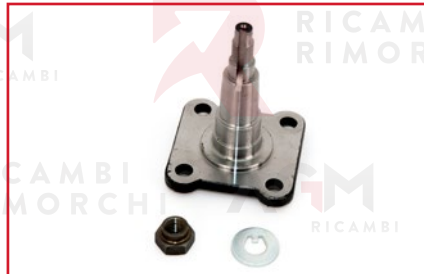

AGM 13281295

ELLEBI FRENO 150/151/185 I'S
+ DADO E RONDELLA

ELLEBI 299380012

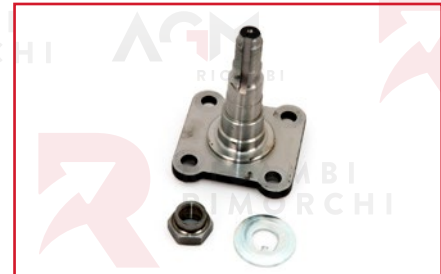

AGM 13281296

ELLEBI FRENO 185 2^S/186
+ DADO E RONDELLA

ELLEBI 299540009



AGM 13281297

ELLEBI FRENO LB 221
+ DADO E RONDELLA

ELLEBI 299425011



AGM 10291298
AL-KO SB 160/SR 160/1635/1637 - 21821503



AGM 10291301
AL-KO 1636/1637 - 570666



AGM 10291300
AL-KO 2050/2051/2360/2361 - 571510



AGM 10292037
AL-KO 3080/3081



AGM 11292148
BPW S2035-7 RASK/S2005-7 RASK



AGM 11292149
BPW S2304-7 RASK/S2504-7 RASK



AGM 13292001
ELLEBI 150
AGM 13292002
ELLEBI 151



AGM 13292003
ELLEBI 185



AGM 13292004
ELLEBI 186



AGM 13292005
ELLEBI 221



AGM 13291302
ELLEBI 150 - 29967008



AGM 13291303
ELLEBI 151 - 299428013

ELLEBI / GSM / KNOTT / OMC



AGM 13291304

ELLEBI 185 - 299540011



AGM 13291305

ELLEBI 186 - 299916015



AGM 13291306

ELLEBI 221 - 299425010



AGM 14291997

GSM 160.35

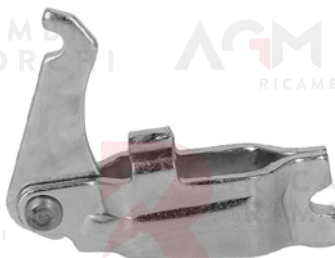

AGM 14291998

GSM 200.35 - 200.50

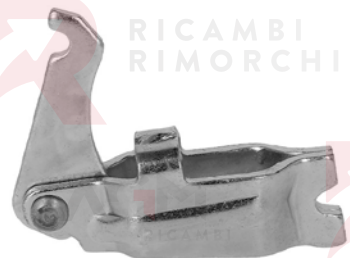

AGM 14292151

GSM 250.40



AGM 12291307

KNOTT 160.35



AGM 12291308

KNOTT 200.30/200.50/203.40/250.40



AGM 16291309

OMC 135.30 AR



AGM 16291310

OMC 160.35 - 160.40



AGM 16291311

OMC 200.35 - 200.50 - 200.60 - 230.40



AGM 16291312

OMC 230.60



AGM 10291897
AL-KO 160x35



AGM 10292540
AL-KO 1637



AGM 10292541
AL-KO 2051/2361



AGM 11292048
BPW S2005-7/S2035-7/S2504-7

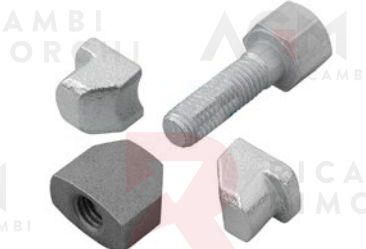

AGM 12292156
KNOTT 160.35/200.30/203.40/200.50
AGM 11292157
KNOTT 250.40



AGM 16292155
OMC 135x30 AR
AGM 16292508
OMC 160/200/230



AGM 14292542
GSM 200X35/200X50



AGM 10292040
AL-KO LEVA RETROM. AUTOM. SX 1637



AGM 10292099
AL-KO LEVA RETROM. AUTOM. DX 1637



AGM 10292105
AL-KO LEVA RETROM. AUTOM. SX 2051



AGM 10292114
AL-KO LEVA RETROM. AUTOM. DX 2051



AGM 10292104
AL-KO PERNO

AL-KO / BPW / KNOTT / OMC / WAP

AL-KO / BPW



AGM 10401510

AL-KO 135.30



AGM 10401511

AL-KO 1636/1637/1640



AGM 10401929

AL-KO SB140/SB141/SB160/
SR160/1635



AGM 10401930

AL-KO 1636G



AGM 10401931

AL-KO 2035/2050 fino a 12-88



AGM 10401512

AL-KO 2035/2050/2051



AGM 10401932

AL-KO 2350/2351 KG. 1300



AGM 10401933

AL-KO 2350/2351 KG. 1600



AGM 10401934

AL-KO 2361 KG. 1600



AGM 11402159

BPW S2005-5



AGM 11402160

BPW S2504-5



AGM 11402161

BPW/HUMBAUR S 2005-5



AGM 13402169
ELLEBI 198SF / N250SF
 ELLEBI 299793001



AGM 13402077
ELLEBI LBN320/N322/W500/LBC443 SF
 ELLEBI 299428050



AGM 13401515
ELLEBI 150/151/185° serie
 ELLEBI 299380015



AGM 13401516
ELLEBI 185/186
 ELLEBI 299540008



AGM 13401517
ELLEBI 220/221
 ELLEBI 299410016



AGM 14401518
GSM 135.30
 ELLEBI 299350023



AGM 14401519
AXF/GSM 160.35



AGM 14401520
AXF/GSM 200.35/200.50



AGM 14402170
AXF/GSM 250.40



AGM 12401522
KNOTT 160.35



AGM 12401523
KNOTT 200.30/203.40/200.50



AGM 12401524
KNOTT 250.40

OMC / WAP



AGM 16401525

OMC 135.30



AGM 16401526

OMC 160.35/160.40



AGM 16401527

OMC 200.35/200.50/230.40



AGM 16402288

OMC 230.60



AGM 23402162

WAP W 184 RS



AGM 23402163

WAP W 235 RS

CUSCINETTI COMPACT



AGM 10391906

30x60x37



AGM 10391907

34x64x37



AGM 10391908

39x72x37



AGM 10391909

42x80x42



AGM 10392449

ANELLO SEEGER Ø 60

AGM 10392543

ANELLO SEEGER Ø 64



AGM 10392544

ANELLO SEEGER Ø 72

AGM 10392545

ANELLO SEEGER Ø 80



AGM 50411988

mm. 15X42X13



AGM 50411962

mm. 17X40X12



AGM 50411963

mm. 20X47X14



AGM 50411911

mm. 17,5x39,9x14,6



AGM 50411937

mm. 17x40x13,2



AGM 50411910

mm. 19,05x45,23x15,49



AGM 50411938

mm. 20x47x15,2



AGM 50411942

mm. 20x52x16,2



AGM 50411943

mm. 25x47x15



AGM 50411939

mm. 25x52x16,2



AGM 50412139

mm. 25X52X22



AGM 50411912

mm. 29x50,3x15,5



AGM 50411940

mm. 30x62x17,2



AGM 50411936

mm. 31,75x59,13x15,87



AGM 50411944

mm. 35x62x18



AGM 50411941

mm. 35x72x18,25



AGM 50412282

mm. 40X68X19



AGM 50301947

mm. 30X47X7

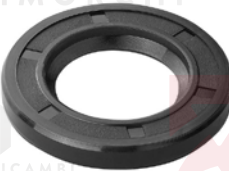

AGM 50301945

mm. 30X52X7



AGM 50301980

mm. 30X62X12



AGM 50302168

mm. 30X63X10



AGM 50302287

mm. 32X52X7



AGM 50302167

mm. 35X62X7



AGM 50302180

mm. 35X62X10



AGM 50302165

mm. 35X72X7



AGM 50301994

mm. 38X50X7

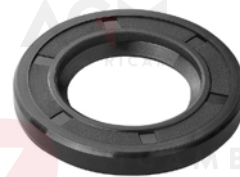

AGM 50302277

mm. 38X55X7

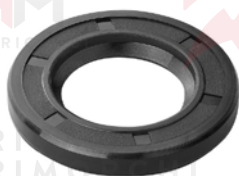

AGM 50302266

mm. 38X62X10

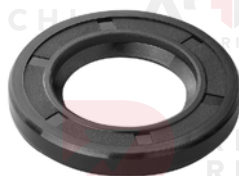

AGM 50301946

mm. 40X52X7

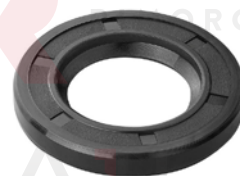

AGM 50301948

mm. 40X62X10



AGM 50301949

mm. 42X62X7

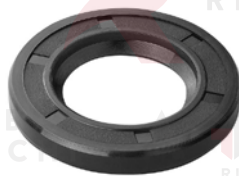

AGM 50302265

mm. 42X72X10



AGM 50302166

mm. 44X56,2X5



AGM 50302164

mm. 44X64,3X5



AGM 50301993

mm. 45,6x56x7



AGM 50302276

mm. 55X68X8

AL-KO / ELLEBI



AGM 10341378

M16X1,5



AGM 10341380

M24X1,5

AGM 10341379

M27X2



AGM 10341998

M24X1,5 - EUROPLUS 1637/2051

AGM 10341959

M24X1,5 - 2361



AGM 13341385

M14 - FRENO 135/150/151/185 I°S

ELLEBI 299350029

AGM 13341386

M18 - FRENO 185 II°/186/221

ELLEBI 299540010



AGM 13341981

FRENO 135/150/151/185 I° S

ELLEBI 298911006

AGM 13341982

FRENO 185 II°S/186/221

ELLEBI 498015031



AGM 50302182

KNOTT RONDELLA DI ARRESTO 250x40



AGM 10302251

AL-KO RONDELLA DI SICUREZZA
Ø 17,5/39X4 MM



AGM 10341381

M16X1,5



AGM 10341382

M18X1,5



AGM 12341916

M20X1,5

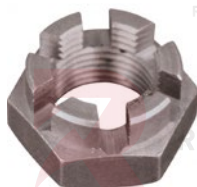

AGM 10341383

M22X1,5



AGM 10341384

M24X1,5

COLONNETTE / COPRIMOZZO



AGM 50361389

M10X1,25X35



AGM 50361390

M12X1,5X4



AGM 50361387

M12X1,5X44



AGM 13362000

M12X1,5 L.15 (conf. 4)

ELLEBI 300199003



AGM 50362438

M12X1,5X44 – ZIGRINATA



AGM 10362113

M14X1,5

AL-KO / ELLEBI / KNOTT / GSM / AXF

BPW / KNOTT / IFOR WILLIAMS / GSM



AGM 10311372

FRENO 1636 G - Ø int. 37

AL-KO 2381250003



AGM 10311368

FRENO 135/160/200/230
Ø int. 48 - H= 23

AL-KO 2083990002



AGM 10311369

FRENO 1637/2051 EURO COMPACT
Ø int. 55

AL-KO 581197



AGM 10311370

FRENO 2361 - Ø int. 54

AL-KO 2687810004



AGM 10311371

FRENO 2361 EURO - Ø int. 63

AL-KO 582505



AGM 13311374

FRENO ELLEBI - Ø int. 47

ELLEBI 498510071



AGM 50311373

UNIVERSALE

Ø int. 47



AGM 12311376

FRENO KNOTT

Ø int. 47



AGM 12311377

FRENO KNOTT

Ø int. 64



AGM 50312032

IFOR WILLIAMS COPRIMOZZO

Ø 75x32



AGM 14312267

FRENO GSM/AXF



AGM 13371462

mm. 1040 - D 2,5

ELLEBI 298303005



AGM 13371463

mm. 770 - D 2,5

ELLEBI 498732001

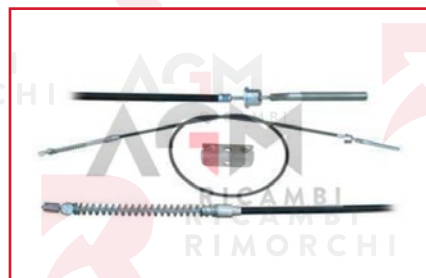

AGM 13371504

135 L. 770

ELLEBI 498872008



AGM 13371505

135 RA L. 1100

ELLEBI 100603020

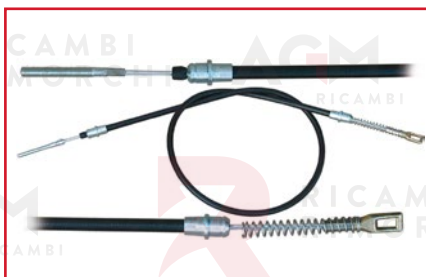

AGM 13371464

GUAINA 1100

ELLEBI 298550032

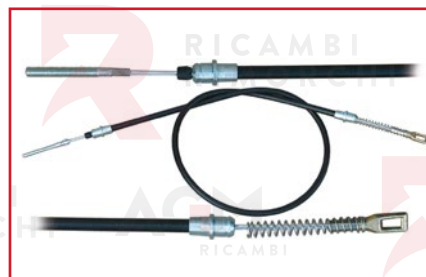

AGM 13371465

GUAINA 1350

ELLEBI 298550034

ELLEBI

AL-KO SB 140/B - PER 135 - SB 141



AL-KO SB - SR - 1635



AL-KO 1625 - 1637 - 2051 - 2361



AL-KO 1636G - 1637 - 2051 - 2361

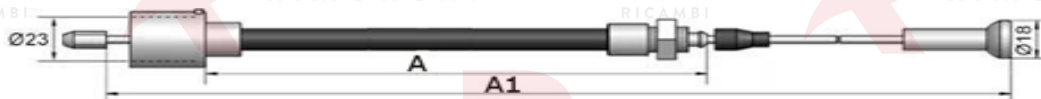

BPW S 1704-7/S 2005-7/S 2035-7/S 2304-7/S 2504-7



GSM/AXF 160.35 - 200.35 - 200.50 - 250.40

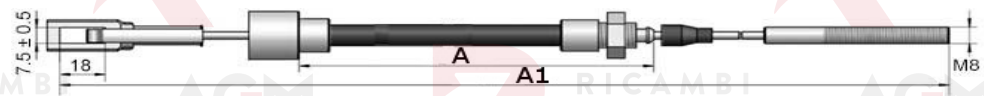

KNOTT 160.35 - 200.30 - 200.50 - 203,2.40 - 250.40



KNOTT 200.30 - 200.50



KNOTT 200.50 - 250.40

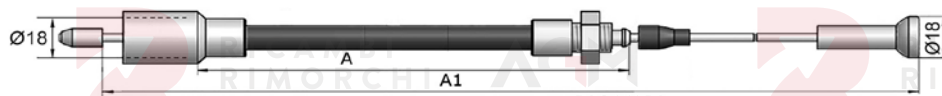

OMC 135.30



OMC 160 - 200 - 230.40 - 230.60

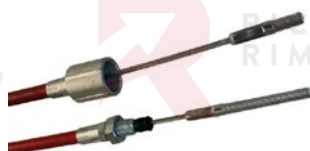

ASOLA SMONTABILE
NON COMPRESA

AL-KO SB 140/B - PER 135 - SB 141		
	A/A1	RIFERIMENTO
AGM 10371391	800/1020	AL-KO 357216
AGM 10371392	1040/1260	AL-KO 357217
AGM 10371393	1220/1440	AL-KO 358758
AGM 10371394	2140	AL-KO 2488310401
AL-KO SB - SR - 1635		
AGM 10371395	560/785	AL-KO 2088800404
AGM 10371396	800/1025	AL-KO 2088800403
AGM 10371397	920/1145	AL-KO 20888004
AGM 10371398	1040/1265	AL-KO 2088800406
AGM 10371399	1160/1385	AL-KO 2088800401
AGM 10371400	1340/1565	AL-KO 2088800402
AGM 10371401	1460/1685	AL-KO 21841804
AGM 10371402	1640/1865	AL-KO 24866304
AGM 10371403	1820/2045	AL-KO 24866305
AL-KO 1625 - 1637 - 2051 - 2361		
AGM 10371404	350/560	AL-KO 299707
AGM 10371405	530/740	AL-KO 299708
AGM 10371406	770/980	AL-KO 299709
AGM 10371407	890/1100	AL-KO 299710
AGM 10371408	1010/1230	AL-KO 299711
AGM 10371409	1130/1340	AL-KO 299712
AGM 10371410	1320/1530	AL-KO 299713
AGM 10371411	1430/1640	AL-KO 299714
AGM 10371412	1620/1830	AL-KO 299715
AGM 10371413	1790/2000	AL-KO 299716
AL-KO 1636G- 1637 - 2051 -2361		
AGM 10371414	350/546	AL-KO 247281
AGM 10371415	520/726	AL-KO 247282
AGM 10371416	770/966	AL-KO 247283
AGM 10371417	890/1086	AL-KO 247284
AGM 10371418	1020/1216	AL-KO 247285
AGM 10371419	1130/1326	AL-KO 247286
AGM 10371420	1320/1516	AL-KO 247287
AGM 10371421	1430/1626	AL-KO 247288
AGM 10371422	1620/1816	AL-KO 247289
AGM 10371423	1790/1986	AL-KO 247290
BPW S 1704-7/S 2005-7/S 2035-7/S 2304-7/S 2504-7		
AGM 11371425	730/955	BPW 05.089.33.77.0
AGM 11371426	830/1055	BPW 05.089.33.78.0
AGM 11371427	930/1155	BPW 05.089.33.80.0
AGM 11371428	1030/1255	BPW 05.089.33.81.0
AGM 11371429	1130/1355	BPW 05.089.33.83.0
AGM 11371430	1230/1455	BPW 05.089.33.84.0
AGM 11371431	1330/1555	BPW 05.089.33.85.0
AGM 11371432	1430/1675	BPW 05.089.33.86.0
AGM 11371433	1530/1755	BPW 05.089.33.87.0
AGM 11371434	1630/1875	BPW 05.089.33.88.0
GSM/AXF 160.35 - 200.35 - 200.50 - 250.40		
AGM 14371467	750/1015	
AGM 14371468	900/1165	
AGM 14371469	1050/1315	
AGM 14371470	1200/1465	
AGM 14371471	1480/1745	
AGM 14371472	1750/2015	

KNOTT 160.35 - 200.30 - 200.50 - 250.40		
	A/A1	RIFERIMENTO
AGM 12372398	530/740	33921.02
AGM 12372399	630/840	33921.03
AGM 12371435	730/940	33921.06
AGM 12371436	830/1040	33921.07
AGM 12371437	930/1140	33921.09
AGM 12371438	1030/1240	33921.11
AGM 12371439	1130/1340	33921.13
AGM 12371440	1230/1440	33921.14
AGM 12371441	1330/1540	33921.15
AGM 12371442	1430/1640	33921.16
AGM 12371443	1530/1740	33921.17
AGM 12371444	1630/1840	33921.18
AGM 12371445	1990/2200	
KNOTT 200.30 - 200.50		
AGM 12371447	700/1000	35006.06
AGM 12371448	800/1100	35006.10
AGM 12371449	900/1200	35006.14
AGM 12371450	1000/1300	35006.16
AGM 12371451	1100/1400	35006.20
AGM 12371452	1200/1500	35006.24
AGM 12371453	1400/1700	35006.28
AGM 12371424	1500/1800	35006.30
AGM 12371454	1600/1900	35006.33
KNOTT 200.50 - 250.40		
AGM 12371446	630/820	980202.03
AGM 12371455	730/920	980202.06
AGM 12371456	830/1020	980202.07
AGM 12371952	930/1120	980202.09
AGM 12371457	1030/1220	980202.11
AGM 12371953	1130/1320	980202.13
AGM 12371458	1230/1420	980202.14
AGM 12371954	1330/1530	980202.15
AGM 12371459	1430/1620	980202.16
AGM 12371460	1530/1720	980202.17
AGM 12371461	1630/1830	980202.18
OMC 135.30		
AGM 16371478	630/795	
AGM 16371479	720/1010	
AGM 16371480	1000/1300	
AGM 16371481	1215/1500	
OMC 160 - 200 - 230.40		
AGM 16371482	520/795	
AGM 16371483	610/885	
AGM 16371484	785/1060	
AGM 16371485	875/1150	
AGM 16371486	925/1200	
AGM 16371487	975/1250	
AGM 16371488	1025/1300	
AGM 16371489	1225/1500	
AGM 16371490	1385/1660	
AGM 16371491	1475/1750	
AGM 16371492	1570/1845	
AGM 16371493	1790/2065	

AL-KO / BPW / KNOTT / OMC / GSM



AGM 10381494

AL-KO OCCHIELLO PER CAVO FRENO
FRENO 160/200/230



AGM 11381495

BPW OCCHIELLO PER CAVO FRENO
FRENO 160/200/230/250



AGM 12381496

KNOTT OCCHIELLO PER CAVO FRENO
FRENO 160/200/203/250



AGM 16381497

OMC OCCHIELLO PER CAVO FRENO
FRENO 135/160/200/230.40



AGM 16381498

OMC OCCHIELLO PER CAVO FRENO
FRENO 230.60



AGM 10381499

AL-KO SEMIGUSCIO
FRENO 160/200/230



AGM 11381500

BPW SEMIGUSCIO
FRENO 160/200/230/250



AGM 12381501

KNOTT SEMIGUSCIO
FRENO 160/200/203/250



AGM 14381502

GSM SEMIGUSCIO
FRENO 160/200/250



AGM 16381503

OMC SEMIGUSCIO
FRENO 160/200/230

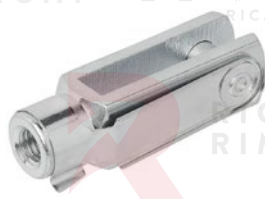

AGM 50381995

FORCELLA M8 (58x20 mm.)



AGM 50381898

FORCELLA M10 (71x20 mm.)

ACCESSORI CAVI FRENO A MANO



AL-KO / ELLEBI / GSM / KNOTT / UNIVERSALE

AMMORTIZZATORI E PARAFANGHI



AL-KO / BPW / KNOTT



AGM 10221989

AL-KO OCTAGON 900 VERDE

L= 250/380



AGM 10222546

AL-KO OCTAGON 1350 AZZURRO

L= 250/380



AGM 10221991

AL-KO OCTAGON 2000 ROSSO

L= 250/380



AGM 10222547

AL-KO 4000 NERO



AGM 10222036

UNIV. 1500/3000



AGM 10222175

COPPIA AMM. TIPO OCTAGON VERDE
KG. 900

L= 250/380



AGM 10222176

COPPIA AMM. TIPO OCTAGON AZZURRO
KG. 900/1300

L= 250/380



AGM 10222177

COPPIA AMM. TIPO OCTAGON ROSSO -
KG. 1300/1800

L= 250/380



AGM 12222410

KNOTT KG. 900/1600

L= 275/380



AGM 12222407

KNOTT KG. 1300/2600

L= 225/335



AGM 12222411

KNOTT KG. 1800/3500

L= 275/380



AGM 12222179

KNOTT KG. 1500/3000



AGM 11222178
 BPW KG. 1500/3000
 L= 350/580



AGM 14222374
 AMMORTIZZATORE KG. 750
 SATELLITE



AGM 13221247
 MONOCAMERA TIPO 3
 ELLEBI 100402008



AGM 13221242
 MECCANICO CON FRIZIONE
 ELLEBI 301002001



AGM 13221243
 IDR. MOLLA GIALLA PERNO/OCCHIO
 ELLEBI 292670016



AGM 13221244
 IDR. MOLLA GRIGIA PERNO/OCCHIO
 ELLEBI 292640013



AGM 13221245
 IDR. MOLLA NERA PERNO/OCCHIO
 ELLEBI 292910018



AGM 13221246
 IDR. MOLLA GIALLA O/O
 ELLEBI 300102015



AGM 13082413
 ELLEBI TAMPONE BARRA STABIL.
 ELLEBI 299745003



AGM 10222018
 AL-KO SUPPORTO PER AMM. AVVITABILE



AGM 10222017
 AL-KO SUPPORTO PER AMM. C/BULL.



AGM 10222253
 AL-KO SUPP. PER AMM. 900/1300/1800

ELELBI / UNIVERSALI



AGM 17231248

RUOTA DA 8"

L=550 - H=140 - S= 160



AGM 17231249

RUOTA DA 10"

L= 610 - H=240 - S= 180



AFM 17231250

RUOTA DA 13"

L=730 - H= 335 - S= 200



AGM 17231251

RUOTA 13"/14"

L= 770 - H= 330 - S= 210



AGM 13232358

PARAFANGO C1150 - 1205

L= 660 - S= 185/ELLEBI 27638



AGM 13232359

PARAFANGO C2205

L= 660 - S= 200/ELLEBI 26876



AGM 13232360

PARAFANGO C2260

L= 760 - S= 220/ELLEBI 26431



AGM 10232181

RUOTA DA 8"



AGM 10232548

RUOTA DA 10"



AGM 17241252

RUOTA DA 13"

L= 700 - H= 380 - S= 185



AGM 17241253

RUOTA DA 14"

L= 800 - H= 400 - S= 220



AGM 17242140

RUOTA 13"/14" TANDEM

L= 1520 - H= 400 - S= 210



AGM 10242021

AL-KO PARAFANGO TANDEM



AGM 10242546

AL-KO PARAFANGO TANDEM

TANDEM

RUOTE COMPLETE / CERCHI / DISCHI

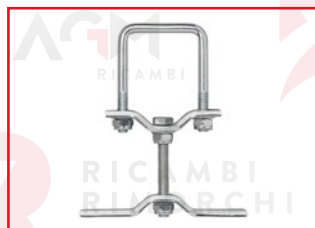

FIG. 1		FIG. 2		FIG. 3	
					
AGM 50431534	2.50. 8	4 x 95 foro centrale 62	4 FORI BALILLA	FIG. 1	
AGM 50431535	2.50. 8	4 x 98 foro centrale 58	4 FORI FIAT	FIG. 1	
AGM 50431537	3.50.10	4 x 95 foro centrale 62	4 FORI BALILLA	FIG. 1	
AGM 50431538	3.50.10	4 x 98 foro centrale 58	4 FORI FIAT	FIG. 1	
AGM 50431917	3.50.10	4 x 100 foro centrale 60	4 FORI TEDESCO	FIG. 1	
AGM 50431539	4.50J 12	4 x 98 foro centrale 58	4 FORI FIAT	FIG. 2	
AGM 50431540	4.50J12	5 x 112 foro centrale 67	5 FORI MERCEDES	FIG. 3	
AGM 50431920	4½ Jx13	5 x 112 foro centrale 67	5 FORI MERCEDES	FIG. 3	
AGM 50431921	4½ Jx13	4 x 98 foro centrale 58	4 FORI FIAT	FIG. 2	
AGM 50431922	4½ Jx13	4 x 100 foro centrale 60	4 FORI TEDESCO	FIG. 2	
AGM 50432486	5 Jx13	4 x 98 foro centrale 58	4 FORI FIAT	FIG. 2	
AGM 50432128	5½ Jx14	4x100 foro centrale 60 mm.	4 FORI TEDESCO	FIG. 2	
AGM 50432129	5½ Jx14	5 x 112 foro centrale 67 mm	5 FORI MERCEDES	FIG. 3	
AGM 50432195	5½ Jx14	5 x 140 foro centrale 94 mm	5 FORI INTERNAZ.	FIG. 3	

FIG. 4		FIG. 5			
					
AGM 50431536	6.00/10	4 x 98 foro centrale 58	4 FORI FIAT	FIG. 4	
AGM 50431533	6.00/10	5 x 112 foro centrale 67	5 FORI MERCEDES	FIG. 5	

FIG. 1		FIG. 2		FIG. 3		FIG. 4	
AGM 50441541	4.00-8"		4 x 98 foro centrale 58		4 FORI FIAT		FIG. 1
AGM 50441542	4.00-8"		4 x 95 foro centrale 62		4 FORI BALILLA		FIG. 1
AGM 50441543	4.00-10" C		4 x 98 foro centrale 58		4 FORI FIAT		FIG. 1
AGM 50441923	4.00-10" C		4 x 95 foro centrale 62		4 FORI BALILLA		FIG. 1
AGM 50441924	4.00-10" C		4 x 100 foro centrale 60		4 FORI TEDESCO		FIG. 1
AGM 50441925	4.00-10" C		4 x 115 foro centrale 85		4 FORI FRANZIA		FIG. 1
AGM 50441544	4.50-10"		4 x 98 foro centrale 58		4 FORI FIAT		FIG. 1
AGM 50441927	4.50-10"		4 x 100 foro centrale 60		4 FORI TEDESCO		FIG. 1
AGM 50441545	5.00-10"		4 x 98 foro centrale 58		4 FORI FIAT		FIG. 1
AGM 50441546	5.00-10"		4 x 100 foro centrale 60		4 FORI TEDESCO		FIG. 1
AGM 50441547	145-10"		4 x 95 foro centrale 62		4 FORI BALILLA		FIG. 2
AGM 50441548	145-10"		4 x 98 foro centrale 58		4 FORI FIAT		FIG. 2
AGM 50441549	145-10"		4 x 100 foro centrale 60		4 FORI TEDESCO		FIG. 2
AGM 50441926	135/80 R 13		4 x 100 foro centrale 60		4 FORI TEDESCO		FIG. 2
AGM 50441551	145/80 R 13		4 x 100 foro centrale 60		4 FORI TEDESCO		FIG. 2
AGM 50441552	155/70 R 13		4 x 98 foro centrale 58		4 FORI FIAT		FIG. 3
AGM 50441553	155 R 13 C4 ET30		4 x 100 foro centrale 60		4 FORI TEDESCO		FIG. 2
AGM 50442452	185 R 14		5 x 112 foro centrale 67		5 FORI MERCEDES		FIG. 3
AGM 50441748	195/50 B 10		4 x 98 foro centrale 58		4 FORI FIAT		FIG. 3
AGM 50441708	195/50 B 10		5 x 112 foro centrale 67		5 FORI MERCEDES		FIG. 3

PORTARUOTA DI SCORTA E CUNEO FERMA RUOTA CON SUPPORTO



AGM 50992190

TUBOLARE 60X60



AGM 50992191

DIM.: 230X160X170

PER RUOTA DA 8/10/12/15 - 4/5 FORI



AGM 17251254

FINO A KG. 900

L= 220 - H= 100 - S= 90



AGM 17251288

FINO A KG. 1600

L= 220 - H= 100 - S= 90

TIMONI / REPULSORI



AL-KO



AGM 10011101

**AK 7 PLUS VERS. A - KG. 750/75 -
TIMONE Ø mm. 35 / AL-KO 1367022**

DIST. FORI: mm. 54 / Ø 12,5



AGM 10011102

**AK 7 PLUS VERS. F - KG. 750/75 -
TIMONE Ø mm. 50 / AL-KO 1367023**

DIST. FORI: mm. 90 / Ø 12,5



AGM 10041103

**AK 7 PLUS 75 V VERS. A KG. 750/75 -
TIMONE Ø mm. 50 / AL-KO 202602**

DIST. FORI: mm.125/Ø 14

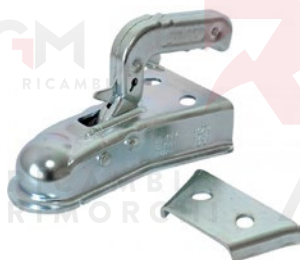

AGM 10042192

**AK 750 VERS. A - KG. 750/75 - ANGOLO
TIMONE 17-26 / AL-KO 1367021**

DIST. FORI: mm. 50/Ø 13,5

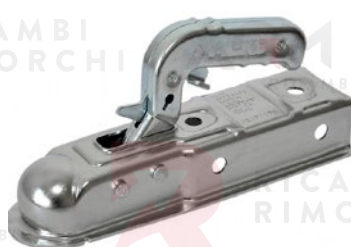

AGM 10021104

**AK 7 VERS. D KG. 750/75
TIMONE mm. 50 / AL-KO 1224339**

DIST. FORI: mm. 90/30 – Ø 10,5

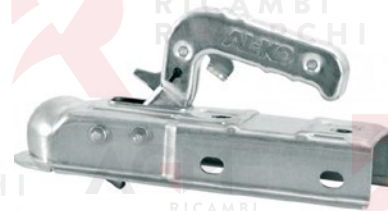

AGM 10021105

**AK 7 VERS. E KG. 750/75
TIMONE mm. 60 / AL-KO 1224343**

DIST. FORI: 80-90/Ø 10,5



AGM 10022020

AK 7 VERS. D Ø 12,5 TIMONE mm. 50

DIST. FORI: mm. 90/Ø 12,5



AGM 10021106

**AK 7 VERS. E KG. 750/75
TIMONE mm. 60 / AL-KO 1224743**

DIST. FORI: mm. 90/Ø 12,5



AGM 10011107
 AK 161 S.D. KG. 1600/120
 TIMONE Ø mm. 50 / AL-KO 1730219
 DIST. FORI: mm. 47-54/Ø 12



AGM 10031112
 AK 161 S.D. KG. 1600/120 - TIMONE Ø
 mm. 50/45/35 / AL-KO 1730218
 DIST. FORI: mm. 47-54/Ø 12



AGM 10032547
 AK 161 KG. 1600/120 SOFT DOCK
 DISTANZIALE Ø mm. 50/35
 DIST. FORI: mm. 47-54/Ø 12



AGM 10011108
 AK 270 S. D. KG. 2700/120
 TIMONE Ø mm. 50 / AL-KO 1730082
 DIST. FORI: mm. 47-54/Ø 12



AGM 10031113
 AK 270 S. D. KG. 2700/120 - TIMONE Ø
 mm. 50/45/40/35 / AL-KO 1730083
 DIST. FORI: mm. 47-54/Ø 12



AGM 10011109
 AK 301 IN GHISA KG. 3000/325 -
 TIMONE Ø mm. 50 / AL-KO 1221746
 DIST. FORI: mm. 45-50/Ø 12,2



AGM 10011110
 AK 351 IN GHISA KG. 3500/350 -
 TIMONE Ø mm. 60 / AL-KO 1222636
 DIST. FORI: mm. 54/Ø 16,2

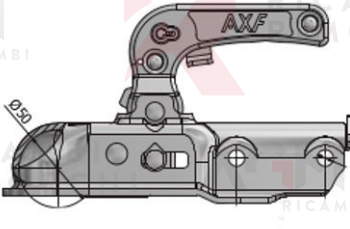

AGM 14011122
 GSM VERS. GE 10-T kg. 1000/75 -
 TIMONE Ø mm. 35
 DIST. FORI: mm.57/Ø 10,5

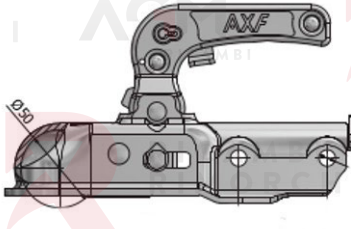

AGM 14011123
 GSM VERS. GE 15-T KG. 1500/100 -
 TIMONE Ø mm. 35
 DIST. FORI: mm. 57/Ø 10,5

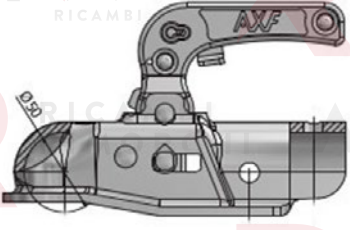

AGM 14011124
 GSM VERS. GE 25-T KG. 2800/120 -
 TIMONE Ø mm. 50
 DIST. FORI: mm. 40/Ø 12,5

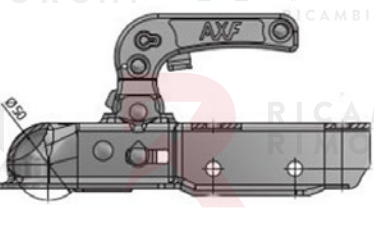

AGM 14021125
 GSM VERS. GE 10-5 KG. 1000/75 -
 TIMONE mm. 50
 DIST. FORI: mm.90/Ø 10,5

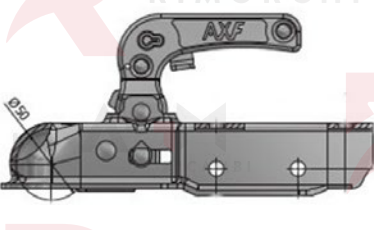

AGM 14021126
 GSM VERS. GE 10-6 KG. 1000/75 -
 TIMONE mm. 60
 DIST. FORI: mm.57/Ø 10,5

KNOTT / OMC / SPP



AGM 12021115

KNOTT KF 7,5 KG. 750/75 - TIMONE
mm. 50

DIST. FORI: mm.90/Ø 12,5



AGM 12021116

KNOTT KF 7,5 KG. 750/75 - TIMONE
mm. 60

DIST. FORI: mm.90/Ø 12,5



AGM 12011117

KNOTT KK 14 KG. 1400/100 - TIMONE
Ø mm. 45

DIST. FORI: mm.40/Ø 12,5



AGM 12011118

KNOTT KF20/KF 17 KG. 2000/100 -
TIMONE Ø mm. 45

DIST. FORI: mm.40/Ø 12,5



AGM 12011119

KNOTT KF27A/ KF25 KG. 2700/150
-TIMONE Ø 50/45

DIST. FORI: mm.40/Ø 12,5



AGM 12011120

KNOTT KF35A KG. 3500/150 - TIMONE
Ø mm. 50

DIST. FORI: mm.40/Ø 12,5



AGM 12011121

KNOTT KF35C KG. 3500/150 - TIMONE
Ø mm. 50

DIST. FORI: mm.54/Ø 14,5

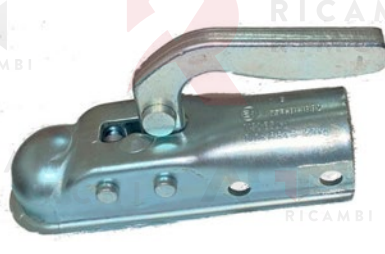

AGM 16011133

OMC MS 1 KG. 1000/75 - TIMONE Ø
mm. 35

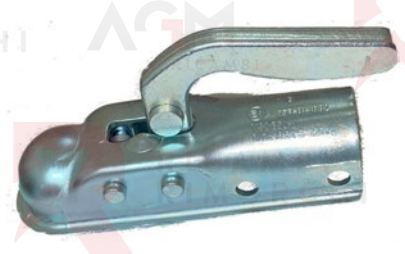

AGM 16011134

OMC MS 2 KG. 1700/100 - TIMONE Ø
mm. 50



AGM 19011127

SPP ZSK 750 KG. 750/75 - TIMONE Ø
mm. 35

DIST. FORI: mm. 54 / Ø 12,5



AGM 19011966

SPP ZSK 750 KG. 750/75 - TIMONE Ø
mm. 50

DIST. FORI: mm. 90 / Ø 12,5



AGM 19011965

SPP ZSK 750 KG. 750/75 - TIMONE Ø
mm. 60

DIST. FORI: mm. 90 / Ø 12,5



AGM 19011128

SPP ZSK 1300 KG. 1300/75 - TIMONE Ø mm. 35

DIST. FORI: mm. 40÷48-54 / Ø 12,5

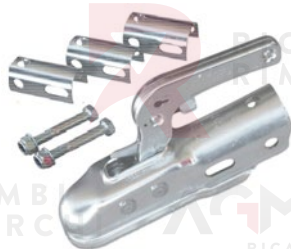

AGM 19011964

SPP ZSK 1300 KG. 1300/75 - TIMONE Ø mm. 50/45/40/35

DIST. FORI: mm. 40÷48-54 / Ø 12,5



AGM 19011129

SPP ZSK 2000 KG. 2000/100 - TIMONE Ø mm. 50

DIST. FORI: mm. 47-54 / Ø 12,5

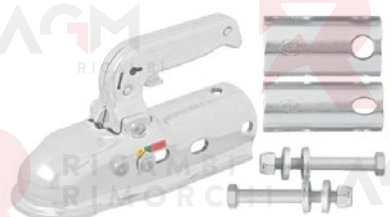

AGM 19012189

SPP ZSK 2300 KG. 2300/150 - TIMONE Ø mm. 50/45/40

DIST. FORI: mm. 40-54 / Ø 12,5



AGM 19012193

SPP ZSK 3000 KG. 3000/150 - TIMONE Ø mm. 50/45/40/35

DIST. FORI: mm. 40-54 / Ø 12,5



AGM 19021130

SPP ZSK 750 KG. 750/75 - TIMONE mm. 50

DIST. FORI: mm. 90



AGM 19021131

SPP ZSK 750 KG. 750/75 - TIMONE mm. 60

DIST. FORI: mm. 90



AGM 19022194

SPP ZSK 1300 KG. 1300/100 - TIMONE mm. 60

DIST. FORI: mm. 90



AGM 19022548

RIDUTTORI PER GIUNTO A SFERA Ø 35/40/45

SPP / STABILIZZATORI KNOTT / AL-KO



AGM 10141781

AL-KO AKS 3004
PORTATA MAX KG. 3000

1225158



AGM 10141782

AL-KO SAFETY KIT AKS 3004
PORTATA FINO A KG. 3000

1225155



AGM 10141783

AL-KO AKS 3504 C/ANTIFURTO
E SAFETY BALL PORTATA MAX KG. 3500

1225761



AGM 12141784

KNOTT KIT STABILIZZATORE KS30
PORTATA MAX KG. 3000



AGM 10142549

AL-KO AKS 1300 KIT FERODI LATERALI



AGM 10142550

AL-KO AKS 2000 KIT FERODI LATERALI
fino al 1992



AGM 10142551

AL-KO AKS 2000/AKS 2004/AKS
3004/3504 KIT FERODI LATERALI



AGM 10142552

AL-KO AKS 2004 KIT FERODI ANT./POST.



AGM 10142553

AL-KO AKS 3004/3504 KIT FERODI ANT./
POST.



AGM 10142554

AL-KO AKS 3004 KIT FERODI ANT./POST.

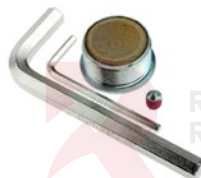

AGM 10142556

WINTERHOFF KIT FERODI WS
fino a 07/1992



AGM 10142557

WINTERHOFF KIT FERODI WS
da 08/1992



AGM 19161222

SFERA DIRITTA PER GIUNTO PORTATA
KG. 2000/120

Ø SFERA mm. 50 - M22X55

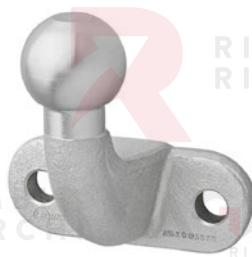

AGM 19162196

SFERA CURVA PER GIUNTO PORTATA
KG. 3500/210

Ø SFERA mm. 50



AGM 19161223

SFERA CURVA PER GIUNTO PORTATA
KG. 2000/120

Ø SFERA mm. 50



AGM 19162197

GANCIO COMBINATO PORTATA KG.
3500/350

Ø SFERA mm. 50/PERNO Ø mm. 25

SPP / KNOTT / AL-KO



AGM 19171224

SPP ANTIFURTO PER CARRELLO
SGANCIATO

UNIVERSALE



AGM 19172199

ANTIFURTO PER CARRELLO SGANCIATO

UNIVERSALE



AGM 19172200

ANTIFURTO PER CARRELLO SGANCIATO

UNIVERSALE



AGM 19171225

SPP ANTIFURTO PER CARRELLO
AGGANCIATO

UNIVERSALE



AGM 19172204

AL-KO LUCCHETTO PER GIUNTO A
SFERA

AK7-AK10

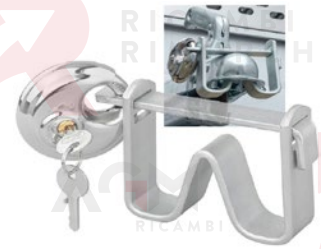

AGM 50172414

ANTIFURTO PER CARRELLO SGANCIATO

UNIVERSALE



AGM 19171226

SPP LUCCHETTO PER GIUNTO A SFERA

UNIVERSALE



AGM 50171742

KNOTT LUCCHETTO PER GIUNTO A
SFERA

KNOTT



AGM 12171743

KNOTT LUCCHETTO PER GIUNTO A
SFERA

K7,5-KK14-K14-KQ14



AGM 12171744

KNOTT LUCCHETTO PER GIUNTO A
SFERA

K20-K24

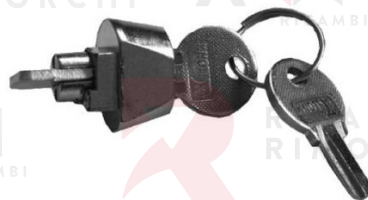

AGM 12171745

KNOTT LUCCHETTO PER GIUNTO A
SFERA

K27-K35



AGM 12141785

KNOTT ANTIFURTO PER STABILIZZATORE

KNOTT

RICAMBI

RICAMBI

RICAMBI

AL-KO



AGM 10172382

AL-KO SAFETY COMPACT

AK 160/300 ATTACCO Ø 50 - 1310890



AGM 10172383

AL-KO SAFETY COMPACT

AKS 2004/3004 - 1310892



AGM 10172384

AL-KO SAFETY COMPACT

AK 160/300 ATTACCO Ø 35 - 1310943



AGM 10172385

AL-KO SAFETY COMPACT

AKS 1300 - 1310944



AGM 10172408

AL-KO LUCCHETTO PER GIUNTO

AK 161/270



AGM 10172559

AL-KO SAFETY AK161/AK270 COMPACT



AGM 10172482

AL-KO SAFETY KIT AK 301/351

RICAMBI
RIMORCHI

AGM
RICAMBI

RICAMBI
RIMORCHI

AGM
RICAMBI

RICAMBI
RIMORCHI

AGM
RICAMBI

RICAMBI
RIMORCHI

AGM
RICAMBI

AL-KO

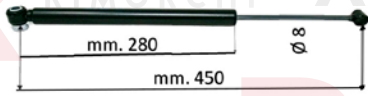

AGM 10061151

30 S/2 VECCHIA VERSIONE - mm. 505

AL-KO 359569 - KG. 400

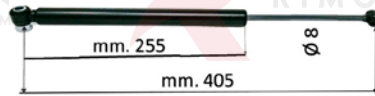

AGM 10061150

30 S/2 NUOVA VERS. ETI 811257 - mm. 405

AL-KO 647010 - KG. 400

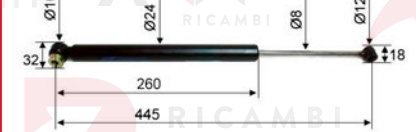

AGM 10061148

60 S/1/2 - mm. 445

AL-KO 20767204 - KG. 600

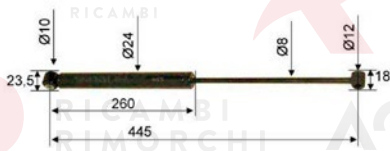

AGM 50061147 - AL-KO 10061149

90 S/2/3 - 101VB-102VB - mm. 445

AL-KO 359987 - KG. 900

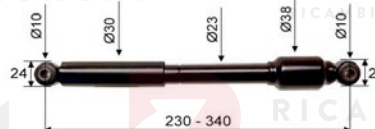

AGM 50062400 - AL-KO 10061158

120 SR/1.3 VB - mm. 345

AL-KO 20775504 - KG. 2000

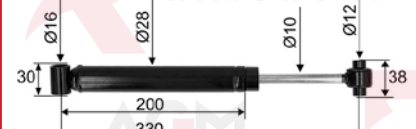

AGM 10062402

131R fino al 1992 mm. 330

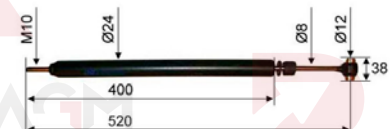

AGM 10061157

150 V - mm. 520

AL-KO 690389 - KG. 1500



AGM 50061729 - AL-KO 10061160

160-200-250 SR/S - mm. 340

AL-KO 20777304 - KG. 2000



AGM 50061726 - AL-KO 10061152

161 S VECCHIA VERSIONE - mm. 325

AL-KO 353936 - KG. 1600



AGM 50061727 - AL-KO 10061153

161 S NUOVA VERSIONE - mm. 505

AL-KO 370556 - KG. 1600

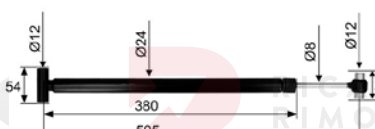

AGM 10061967

161 S (KG. 700/1350) - mm. 505

AL-KO 583529 - KG. 1600



AGM 10061159

200 V - mm. 535

AL-KO 690388 - KG. 2000

AGM 50061154
 251 S - DAL 1985 AL 1988 - mm. 325
 AL-KO 355338 - KG. 2500

AGM 50061728 - AL-KO 10061155
 251 S NUOVA VERSIONE - mm. 505
 AL-KO 370589 - KG. 2500

AGM 10061156
 251 S VECCHIA VERSIONE - mm. 330
 AL-KO 373202 - KG. 2500

AGM 10061968
 251 VB-2 n° ETI 811345 - mm. 330
 AL-KO 372641 - KG. 2500

AGM 50061730 - AL-KO 10061161
 2.8 VB - 2.8 VB/1 - mm. 610
 AL-KO 21726604 - KG. 3500

AGM 10061969
 351 VB-2 n° ETI 811346 - mm. 415
 AL-KO 372854 - KG. 3500

AGM 11062361
 BPW ZAV1.05-2 (300X151XØ24)
 L. mm. 300 - KG. 1000

AGM 11062362
 BPW ZAF1.0-1, ZAF1.0-2, ZAF1.5-2 (310X185XØ24)
 L. mm. 310 - KG. 1500

AGM 11062363
 BPW ZAF1.5-2
 L. mm. 310 - KG. 1500

AGM 11062202
 BPW ZAF 1.6-1
 L. mm. 335 - KG. 1600

AGM 11062203
 BPW AMM.RE REP.RE SR 2.7
 L. mm. 230 - KG. 2700

AGM 11062364
 BPW ZAF2.8-2 (340X220XØ29)
 L. mm. 340 - KG. 2800

BPW / ELLEBI / GSM

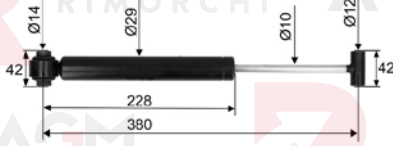

AGM 11062205

BPW AMM.RE REP.RE ZAF 3.5-1

L. mm. 380 - KG. 3500



AGM 13061162

CFR 300 (RIF. 520 - 01) - mm. 360

ELLEBI 298510032



AGM 13061163

CFR 540 (RIF. 520 - 02) - mm. 360

ELLEBI 298520011



AGM 13061164

CFR 1000 (RIF. 520 - 03) - mm. 360

ELLEBI 298550024



AGM 13061165

CFR 2000 (RIF. 520 - 04) mm. 360

ELLEBI 298913004



AGM 13062206

CFR 2000 (RIF. 04 K) mm. 504 - foro Ø mm. 14

ELLEBI 298913001



AGM 14061170

GSM TIMONE RF2 - mm. 445

KG. 650/1000



AGM 14061992

GSM TIMONE R4/A - mm. 345

KG. 900/1300



AGM 14061171

GSM TIMONE A "V" RF3B - mm. 445

KG. 900/1500



AGM 14061172

GSM TIMONE A "V" mm. 535

KG. 950/1800



AGM 14061173

GSM TIMONE RF5 - mm. 535

KG. 1500/2800



AGM 12062208

KNOTT KF7,5C/KR7,5C/KRV7,5C
mm. 534 - KG. 750

87000313/87000309



AGM 12062209

KNOTT KFL12-C/KFL14-C
mm. 411 - KG. 750

87100313/87100309



AGM 12062210

KNOTT KR13HV/KR13/82, KHD9
mm. 534 - KG. 900

87000513 - 87000509

KNOTT



AGM 50061166

KNOTT KF/KR/KRV/KR-HV/KV-HV/KV13
mm. 534 - KG. 1400

87000713 - 87001109

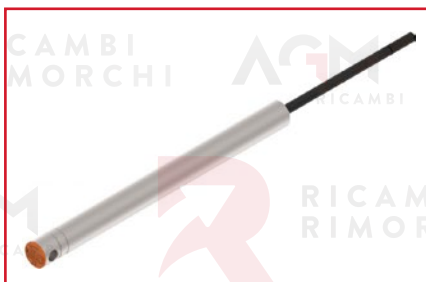

AGM 12062207

KNOTT KF17E/KRV17E, HKD15
mm. 534 - KG. 1700

87004713 - 87004709



AGM 50061167

KNOTT KF17-C/KF20/KR17-20
mm. 534 - KG. 2000

87001113 - 87001109



AGM 12062211

KNOTT KF30A/KR30A/KR30HV-A
mm. 666 - KG. 2600

87001313 - 87001309



AGM 12062212

KNOTT KF27-B
mm. 530 - KG. 2700

8700311314 - 8700310914

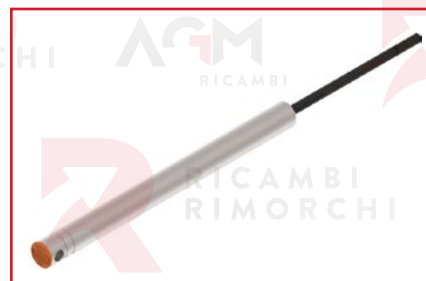

AGM 50061168

KNOTT KF27A1, A2/KFG30/KR20D8
mm. 530 - KG. 3000

87003913 - 87003909



AGM 50062012

KNOTT KF30C/C1/D, KR30B, KR30HVB
mm. 669 - KG. 3000

87001413 - 87001409/S



AGM 12062213

KNOTT KFZ35-E/KFGL35-D
mm. 697 - KG. 3500

87004313 - 87004309



AGM 12062214

KNOTT KFG/KR/KHA35, KHD35, KFG45
mm. 585 - KG. 3500

87003613 - 87003609

KNOTT / OMC



AGM 12062509

KNOTT AMM. REP.RE KF25A, KFG27,
KV20HV - KG. 2700

87003109/87003113

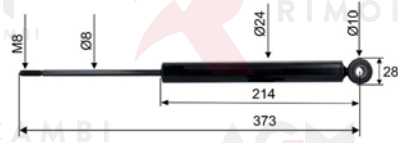

AGM 16061174

OMC KG. 750 - FILET. M8

L. mm. 373



AGM 16061175

OMC KG. 750/1300 - FILET. M10

L. mm. 373



AGM 16061176

OMC KG. 1300/1800 - FILET. M10

L. mm. 373

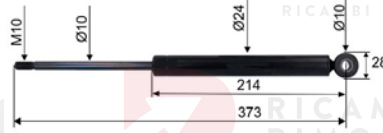

AGM 16061177

OMC KG. 1800/2500 - FILET. M10

L. mm. 373



AGM 16061951

OMC KG. 2500/3500 - FILET. M10

L. mm. 386



AGM 10072560

AL-KO ALBERINO 30 S/2



AGM 10072561

AL-KO ALBERINO 90 S/1 - 90 S/2



AGM 10072562

AL-KO ALBERINO 90 S/3



AGM 10072563

AL-KO ALBERINO 60 S/2 - 90 S/3



AGM 16072370

OMC ALBERINO 345/675 Q



AGM 16072371

OMC ALBERINO 345/675 AR



AGM 16072372

OMC ALBERINO 17/100 R55

AL-KO / OMC

AL-KO / BPW

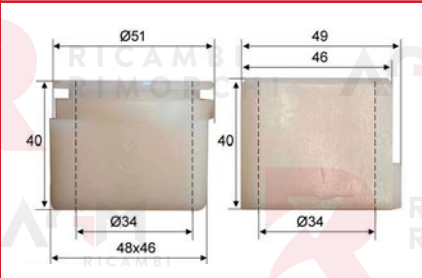

AGM 10081179

30S/2 - 60S 1/2 - 90S 2/3 -
1.3VB/120S/SV/SR - A+P

AL-KO 1210678

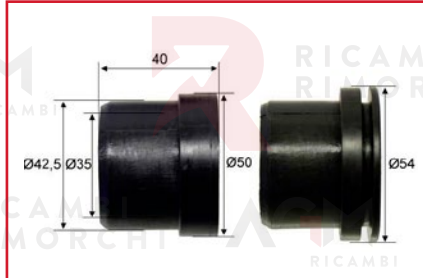

AGM 10081180

30 S/2 - 60 S 1/2 - 90 S/2/3
120 SR - 1.3 VB

AL-KO 1210679

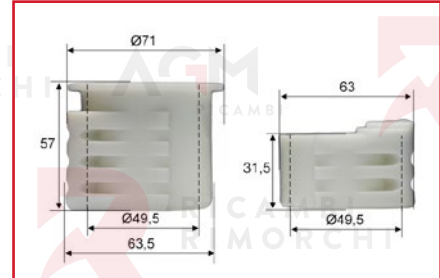

AGM 10081178

131R - 161S / VB/250S/251S/351ZA -
ANT.+POST.

AL-KO 1210131

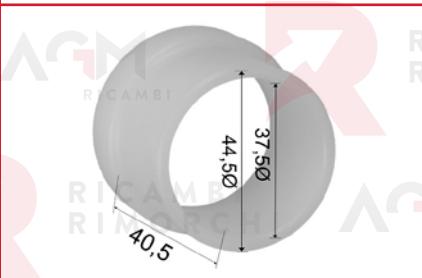

AGM 10082031

160S/SV/SR/1 - L 40,5-Ø e. 44,5-Ø i.
37,5 - POST.

AL-KO 2173450207



AGM 10082028

200S/SV/SR VERS.B/2.0VB/101VB - L
50 - Ø e. 52,3 - Ø i. 40 - A+P

AL-KO 2075580103



AGM 10082029

200S/SV/SR VERS.B/2.0VB/101VB - L
40 - Ø e. 52,3 - Ø i. 40 - A+P

AL-KO 2077030201



AGM 10082030

2,8VB/2-351VB/43V/43ZA - L.60-Ø e.
70,3-Ø i. 60,2-A.+P.

AL-KO 2172660004



AGM 10081191

30 S/60 S/90 S/120/160 - Ø 35X43X10
AL-KO 2072410207

AGM 10081193

161/251 - Ø 50X57X10
AL-KO 371372



AGM 10081192

200/101/2.0 - Ø 40X50X10

AL-KO 2077030202



AGM 14062027

AXF/GSM BOCCOLA POST.
mm. 35,5x42x56



AGM 11082219

BPW 1.0-1/1.0-2 - A+P.

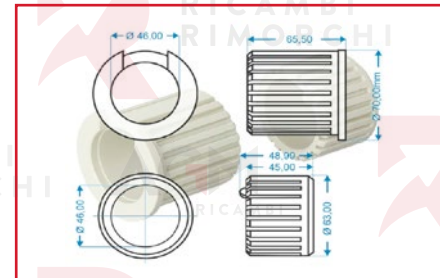

AGM 11082215

BPW 1.3-2.0 A+P Ø EST. mm. 63,
Ø INT. mm. 46, H mm. 45 /
Ø EST. mm. 70, Ø INT. mm. 46,
H mm. 65,50

RICAMBI

RICAMBI

RICAMBI

BPW / KNOTT / OMC



AGM 11082217

BPW 1.35-1/ 1.6-1 - A+P

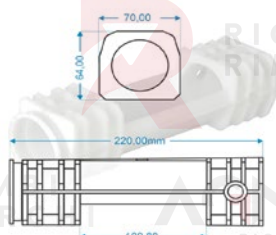

AGM 11082216

BPW 1.5-2/1.6-3/2.0-2 - A+P



AGM 11082220

BPW 1.6-1/ 2.0-1/PAV SR 0.85 - A+P



AGM 11082218

BPW 2.8-1 - A+P

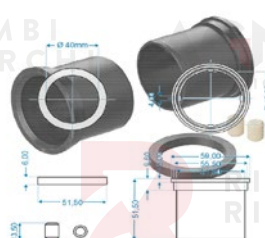

AGM 12081181

KNOTT KF/KR 7,5-10-13-20 - A+P

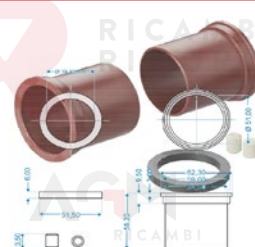

AGM 12081747

KNOTT KF27/KF30C/KRV30B - A+P



AGM 12082221

KNOTT KFG35, KRV35, KR35 (Ø 50X5)



AGM 16081186

OMC POST. TONDA

TIMONE 345 AR - 675 AR



AGM 16081187

OMC ANT. TONDA

TIMONE 345 AR - 675 AR



AGM 16081190

OMC mm. 170 X 60 - Ø mm. 35

TIMONE 345Q/675 Q



AGM 16081188

OMC POST. QUADRA

TIMONE 10/70 - 10/80



AGM 16081189

OMC ANT. QUADRA

TIMONE 10/70 - 10/80

RICAMBI
RIMORCHI

RICAMBI

RICAMBI
RIMORCHI

RICAMBI

AL-KO / ELLEBI / GSM / KNOTT



AGM 10051135

30/60/90/120/160/200/250/1.3/
2.0 - L. 118 - Ø 30/40

AL-KO 2073890210



AGM 10051136

161S/251S - L. 125 - Ø 50/60

AL-KO 366356



AGM 10051137

2.8 VB - 351S - L. 115 - Ø 55/70

AL-KO 21726605



AGM 10052067

AKS 2004/AKS 3004/351ZA - L. 80 - Ø
55/35

AL-KO 607133



AGM 11082222

BPW B1.0-1 - Ø 45/60 L.150



AGM 11082223

BPW 1.35-1/1.6-1/2.0-1
Ø 60x(50x40) L=145



AGM 13051138

4 CRESTE - L. mm. 130 - Ø 45/55

ELLEBI 498916007



AGM 13051139

5 CRESTE - L. mm. 110 - Ø 34/48

ELLEBI 298550029



AGM 14051142

GSM/AXF TIMONE TONDO TQ/TV/TV3

KG. 650/900/950



AGM 14051143

GSM/AXF TIMONE TONDO TQ2/TV2

KG. 950/1000/1300/1500/2800



AGM 14051144

GSM/AXF TIMONE QUADRO VKT

KG. 650/950/1000/1300/1500/2800



AGM 12051140

KNOTT KF/KR/KV/KFG/KFL/KRV
7,5/13/17/20/25/27/30

L. mm. 135 - Ø 55/55 RIF. ELLEBI 20803



AGM 12052249

KNOTT KF27-A/A1/A2, KF27-B, KF30-A, KF30-E, KFG27-A, KFG30-A

L. mm. 165 - Ø 60/70



AGM 12051141

KNOTT KF/KRV/KFG 27/30/35

L. mm. 150 - Ø 70/75



AGM 12051724

KNOTT KR/KF 7,5-30

L. mm. 170 - Ø 55/55



AGM 12051956

KNOTT KF/KRV/KFG 27/30/35

L. mm. 150 - Ø 75/75 RIF. ELLEBI 26532



AGM 12051918

KNOTT

L. mm. 140 - Ø 55/60



AGM 16051145

OMC 345/675/750/10-70/13-70/....

L. mm. 130 - Ø 35/50



AGM 50052225

PEITZ

L. 100 Ø 55/70



AGM 50052226

PEITZ

L. 150 Ø 60/70



AGM 50052224

BPW

L 120-Ø 45/60



AGM 50052227

IFOR WILLIAMS

L. 187 Ø 80

KNOTT / OMC / APPLICAZIONI VARIE

AL-KO



AGM 10121207

30 S/2

AL-KO 385744



AGM 10121203

60S/2 - 90S/3 PERNO CON STAFFA
RETROMARCIA

AL-KO 354001



AGM 10121208

60S/1-90S/2-120/160/200/250/1.3/
2.0/2.8 VB

AL-KO 204548



AGM 10121201

60 S/90S/120S/160/200/131/161

AL-KO 204549

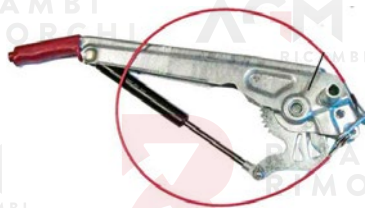

AGM 10121210

90 S/3 MOLLA A GAS (perno Ø 16)

AL-KO 299230



AGM 10121204

90 S/3 MOLLA A GAS (perno Ø 19)

AL-KO 220094



AGM 10121209

161 S (perno Ø 16)

AL-KO 299229



AGM 10121202

161 S/251 S (perno Ø 19)

AL-KO 220096



AGM 10121211

161 S - 251 S

AL-KO 220097



AGM 10121205

251 S (perno Ø 16)

AL-KO 219010

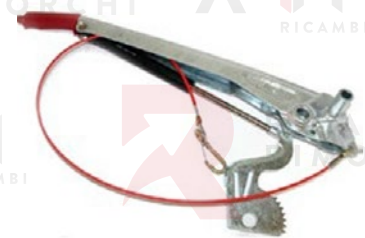

AGM 10121206

251 S (perno Ø 19) fino al 07/1995

AL-KO 220098

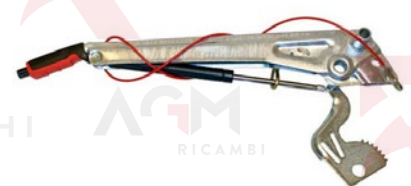

AGM 10121212

251 S

AL-KO 220099

LEVE FRENO A MANO



AGM 14121213
RF3B STD - KG. 1500
GSM/AXF



AGM 14121214
RF4/5 - KG. 2800
GSM/AXF



AGM 12122228
KF/KR
KNOTT



AGM 12122229
KF 13 C
KNOTT



AGM 16121215
345 AR - 345/Q
OMC



AGM 16121216
675 AR - 675/Q
OMC



AGM 16121217
10/70/80-17/100 22/100

OMC



AGM 10132115
AL-KO MANIGLIA DI PROTEZ. LEVA FR. A MANO



AGM 10132116
AL-KO MANIGLIA DI PROTEZ. LEVA FR. A MANO



AGM 50122280
L. 275 C/CARRUCOLA

AGM



AGM 50122281
L. 345 C/CARRUCOLA

AGM



AGM 10131218
60 S/1/2 - 90 S/2/3 - 120 S - 1.3 VB - mm. 140, Ø 38

AL-KO 2075020601

AL-KO



AGM 10131219

30S/2 - mm. 140, Ø mm. 38

AL-KO 385758



AGM 10131220

160SR/161S/200SR/250S/2,0VB/251S/251G
- mm. 170 - Ø 38

AL-KO 2077050601



AGM 10131221

2.8 VB - mm. 210, Ø 43

AL-KO 2178348



AGM 10132104

AL-KO MOLLA A GAS LEVA FR. A MANO

161S/251S

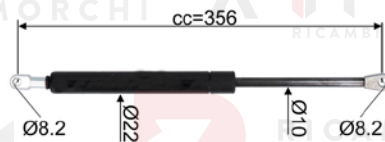

AGM 10132105

AL-KO MOLLA A GAS LEVA FR. A MANO

251S/251G



AGM 10092567

AL-KO LEVA DI RINVIO 60 S/2 - 90 S/3

(rapporto 90:27) - dal 11/96



AGM 10092568

AL-KO LEVA DI RINVIO 60 S/2

(rapporto 90:23) - dal 11/96



AGM 10092569

AL-KO LEVA DI RINVIO 60 S/2 - 90 S/3

(rapporto 90:27) - dal 11/96



AGM 10092570

AL-KO LEVA DI RINVIO 161S/ 251 S
quadro 100

dal 11/96



AGM 10092571

AL-KO LEVA DI RINVIO 161 S

(rapporto 90:27)



AGM 17111200

Ø mm. 3 - LUNGHEZZA mm.1000



AGM 50111957

Ø mm. 3 - LUNGHEZZA mm.1000

RIF. 368605

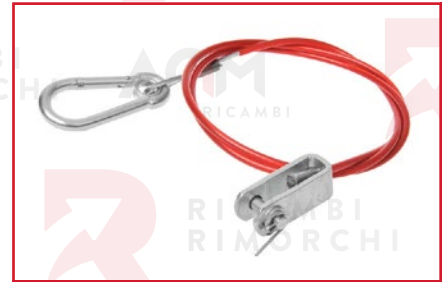

AGM 12112060

Ø mm. 3 - LUNGHEZZA mm.1000



AGM 10111199

Ø mm. 3 - LUNGHEZZA mm. 1350

AL-KO 209510



AGM 50111900

Ø mm. 3 - LUNGHEZZA mm.1500



AGM 10112034

Ø mm. 3 - LUNGHEZZA mm. 1600

AL-KO 209534



AGM 10112110

AL-KO FUNE DI SICUREZZA D. mm. 3
L. mm. 1000

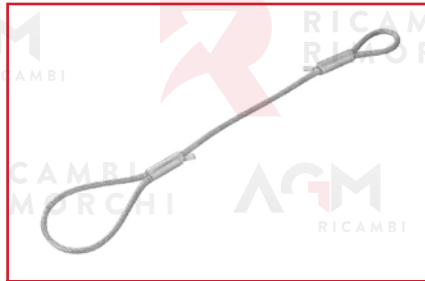

AGM 50112130

CAVO DI SICUREZZA A STRAPPO
PER SFRENATI L. 400



AGM 10112109

ELLEBI CAVO DI SICUREZZA D. mm. 6
L. mm. 1100

RUOTINI / SUPPORTI / COPERTURE





AGM 17181227

FISSO TUBO Ø mm. 35 - H mm. 600

RUOTA PLS mm. 150X40

PORTATA STATICA KG. 75



AGM 17181228

TELES. TUBO Ø mm. 35 - H mm. 565/755

RUOTA PLS mm. 160X40

PORTATA STATICA KG. 75



AGM 50182412

**TELES. TUBO Ø mm. 35
H mm. 490/680**

RUOTA PLS mm. 160X40

PORTATA STATICA KG. 125



AGM 17181229

TELES. TUBO Ø mm. 48 - H mm. 575/790

RUOTA LAM. mm. 200X50

PORTATA STATICA KG. 150



AGM 10182239

**AL-KO TUBO Ø mm. 48 - H mm. 640/890
ANTISCIVOLO**

RUOTA ACCIAIO mm. 200X50

PORTATA STATICA KG. 300



AGM 10182346

AL-KO TUBO Ø mm. 48

RUOTA LAM. mm. 200X50

PORTATA STATICA KG. 300



AGM 50182230

**TELES. TUBO Ø mm. 60
H mm. 470/640**

RUOTA ACCIAIO mm. 200X60

PORTATA STATICA KG.300



AGM 50181230

**TELES. TUBO Ø mm. 60
H mm. 640/880**

RUOTA LAM. mm. 220X65

PORTATA STATICA KG. 250



AGM 10182572

TELES. TUBO Ø mm. 60

RUOTA ACCIAIO mm. 200X50

PORTATA STATICA KG. 500



AGM 50182228

**TELES. DOPPIO - TUBO Ø mm. 48
H mm. 660/870**

RUOTA PNEUM. mm. 260X85

PORTATA STATICA KG.300



AGM 50182229

**TELES. DOPPIO - TUBO Ø MM. 48
H 550/770**

RUOTA ACCIAIO mm. 200X50

PORTATA STATICA KG. 150



AGM 50202233

MANIGLIA PER MANOVRE

TUBO Ø 48



AGM 50202234

MANIGLIA PER MANOVRE

TUBO QUADRO E TONDO mm. 60



AGM 50182118

MANOVELLA PER RUOTINO Ø 35

PER RUOTINO 50182412



AGM 50182119

MANOVELLA PER RUOTINO Ø 60

PER RUOTINO 50181230

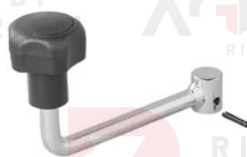

AGM 50182397

MANOVELLA PER RUOTINO Ø 60

PER RUOTINO 50182230



AGM 50181970

TUBO mm. 48 H= mm. 700

PORTATA STATICA KG.300



AGM 50181971

TELES. TUBO mm. 48 H= mm. 400/650

PORTATA STATICA KG.300



AGM 50182564

PIEDINO STABILIZZATORE BILATERALE
KG. 500



AGM 50182565

PIEDINO STABILIZZATORE BILATERALE
KG. 800



AGM 50182529

PIEDINO STABILIZZATORE
LATO ANT. DX/POST. SX KG. 800



AGM 50182530

PIEDINO STABILIZZATORE
LATO ANT. SX/POST. DX KG. 800



AGM 17191232

SUPPORTO PER RUOTINO TELESCOPICO

TUBO Ø mm. 35



AGM 17191233

SUPPORTO PER RUOTINO TELESCOPICO

TUBO Ø mm. 48



AGM 50191928

SUPPORTO PER RUOTINO TELES.
PIASTRA IN GHISA A SEI FORI

TUBO Ø mm. 48



AGM 50192240

SUPPORTO PER RUOTINO TELES.
ANTISCIVOLO

TUBO Ø mm. 48



AGM 50191234

SUPPORTO PER RUOTINO TELESCOPICO

TUBO Ø mm. 60



AGM 17191231

SUPPORTO PER RUOTINO FISSO

TUBO Ø mm. 35



AGM 50201901

RUOTA IN GOMMA PIENA 200x50

FORO Ø mm. 20x60

PORTATA KG. 150



AGM 50202232

RUOTA IN GOMMA PIENA 200x60

FORO Ø mm. 20x60

PORTATA KG. 400



AGM 50202231

RUOTA IN POLIURETANO 260X85

FORO Ø mm. 20x60

PORTATA KG. 150



AGM 50202439

RUOTA IN PLS 200x50

FORO Ø mm. 20x60

PORTATA KG. 120



AGM 50202065

RUOTA IN GOMMA PIENA
CERCHIO IN ACCIAIO mm. 215X65

FORO Ø mm. 20x60

PORTATA KG. 250

COPERTURE DI PROTEZIONE



AGM 50982242

PER 2 BICI CON VANO PER TARGA
SEGNALETICA

TESSUTO: NYLON



AGM 50982243

PER 2 BICI CON VANO PER TARGA
SEGNALETICA

TESSUTO: NYLON RIPSTOP



AGM 50982244

PER 2 BICI

TESSUTO: NYLON



AGM 50982245

PER 2 BICI - ANTERIORE

TESSUTO: NYLON



AGM 50982246

PER 2 BICI - ANTERIORE

TESSUTO: NYLON RIPSTOP



AGM 50982247

PER 2 BICI ELETTRICHE ANTERIORE XL

TESSUTO: NYLON



AGM 50812369

TELO PROTETTIVO TIMONE

TESSUTO: NYLON



AGM 50811740

MANOPOLA FISSAGGIO TELONE

Ø mm.19/25 - H mm. 13

FANALERIA





AGM 50742014

Ø 140 - H 135 - 12/24V
C/CAVO MT. 3
BASE MAGNETICA E VENTOSA



AGM 50742015

Ø 128/24 - H 210 - 12/24V
GAMBO FLESSIBILE



AGM 50742305

Ø 120 - H 92 - 12/24V
C/CAVO MT. 3
BASE MAGNETICA



AGM 50541749

DX 5 FUNZIONI (POS, STOP, DIR, LT, RM)
CAVO mm. 1850
163X144X40 - INTERASSE 108
WAS W68P - 12/24V



AGM 50541750

SX 5 FUNZIONI (POS, STOP, DIR, LT, RN)
CAVO mm. 1850
163X144X40 - INTERASSE 108
WAS W68P - 12/24V



AGM 50542278

DX 6 FUNZIONI
(POS, STOP, DIR, LT, RN, RM)
198X171X43 - INTERASSE 152
RADEX 6700 - 12V



AGM 50542279

SX 6 FUNZIONI (POS, STOP, DIR, LT, RN, RM)
CAVO mm. 300
198X171X43 - INTERASSE 130
RADEX 6700 - 12V



AGM 50542289

DX/SX 3 FUNZIONI (POS, STOP, DIR)
CAVO mm. 250
Ø 140X29
LED 50 - 12/24V

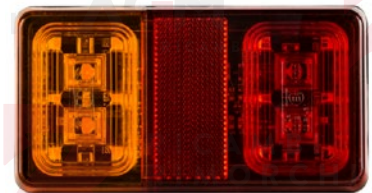

AGM 50542368

DX/SX 3 FUNZIONI (POS, STOP, DIR) /
CAVO mm. 300
150X80X21 INTERASSE FORI 100
LED 16 - 12/24V



AGM 50542250

DX/SX 4 FUNZIONI (POS, STOP, DIR, LT)
CAVO mm. 250
95X106X38 - INTERASSE 55
LED 14 - 12V



AGM 50571751

ROSSO 12/24V (CAVO 2x0,50 - CM. 15)

110X42X9 - interasse fori 74



AGM 50571724

SUPPORTO IN PLASTICA PER FANALI

Interasse fori 30



AGM 50571755

GOMMA IN PLASTICA PER FANALI



AGM 50562358

SX INCLINATO 90° BIANCO/ROSSO/
ARANCIONE LED

105X134X48 - 12/24V



AGM 50562359

DX INCLINATO 90° BIANCO/ROSSO/
ARANCIONE LED

105X134X48 - 12/24V



AGM 50562357

DX INCLINATO 90° BIANCO/ROSSO/
ARANCIONE LED

105X178X48 - 12/24V



AGM 50562312

SX INCLINATO 90° BIANCO/ROSSO/
ARANCIONE LED

105X178X48 - 12/24V



AGM 50571753

ARANCIO 12/24V LED (CAVO 2x0,50 - CM. 15)

110X42X9 - interasse fori 74



AGM 50571756

ARANCIO 12/24V LED (CAVO 2x0,50 - CM. 60)

96X30X26 - interasse fori 70



AGM 50571761

ARANCIO 12/36V LED (CAVO 2x0,75 - CM. 40)

65X42X30



AGM 50571762

ARANCIO 12/36V LED (CAVO 2x0,75 - CM. 40)

95X65X33



AGM 50571763

ARANCIO 12/36V LED (CAVO 2x0,75 - CM. 40)

96X42X33



AGM 50572314

ARANCIO 12/24V LED - CAVO CM. 30

140X33X17 - Interasse fori 111



AGM 50572315

ARANCIO 12/24V LED - CAVO CM. 30

96X30X7 - Interasse fori 86



AGM 50571724

SUPPORTO IN PLASTICA PER FANALI

Interasse fori 30



AGM 50571755

GOMMA IN PLASTICA PER FANALI

FANALI DI POSIZIONE LATERALI LED



AGM 50571752

BIANCO 12/24V (CAVO 2x0,50 - CM. 15)

110X42X9 - interasse fori 74



AGM 50571757

BIANCO 12/36V LED (CAVO 2x0,75 - CM. 40)

65X42X30



AGM 50571758

BIANCO 12/36V LED (CAVO 2x0,75 - CM. 40)

140X65X34



AGM 50571759

BIANCO 12/36V LED (CAVO 2x0,75 - CM. 40)

95X65X33



AGM 50571760

BIANCO 12/36V LED (CAVO 2x0,75 - CM. 40)

96X42X33



AGM 50572316

BIANCO 12/24V LED - CAVO CM. 30

140X33X17 - Interasse fori 111



AGM 50572317

BIANCO 12/24V LED - CAVO CM. 30

96X30X7 - Interasse fori 86



AGM 50572318

BIANCO 12/24V LED (CAVO 2x0,50 - CM. 15)

110X42X9 - interasse fori 74



AGM 50571724

SUPPORTO IN PLASTICA PER FANALI

Interasse fori 30



AGM 21511563

DX 5 FUNZIONI (POS/STOP/DIR/LT/RN)

RADEX 2900

180x240x60 - INTERASSE FORI 130



AGM 21511564

DX 5 FUNZIONI (POS/STOP/DIR/LT/RM)

RADEX 2900

180x240x60 - INTERASSE FORI 130



AGM 21511565

SX 5 FUNZIONI (POS/STOP/DIR/LT/RN)

RADEX 2900

180x240x60 - INTERASSE FORI 130



AGM 21511568

DX 4 FUNZIONI (POS/STOP/DIR/RN)

RADEX 5001

196X106X61 - INTERASSE FORI 55



AGM 21511569

DX 4 FUNZIONI (POS/STOP/DIR/RM)

RADEX 5001

196X106X61 - INTERASSE FORI 55



AGM 21511570

SX 4 FUNZIONI (POS/STOP/DIR/RN)

RADEX 5001

196X106X61 - INTERASSE FORI 55



AGM 21511571

DX 5 FUNZIONI (POS/STOP/DIR/LT/RN)

RADEX 5001

196X106X61 - INTERASSE FORI 55



AGM 21511572

DX 5 FUNZIONI (POS/STOP/DIR/LT/RM)

RADEX 5001

196X106X61 - INTERASSE FORI 55



AGM 21511573

SX 5 FUNZIONI (POS/STOP/DIR/LT/RN)

RADEX 5001

196X106X61 - INTERASSE FORI 55



AGM 21512085

DX 5 FUNZIONI (POS/STOP/DIR/LT/RM)

RADEX 5600

215X100X55 - INTERASSE FORI 155



AGM 21512086

SX 5 FUNZIONI (POS/STOP/DIR/LT/RN)

RADEX 5600

215X100X55 - INTERASSE FORI 155



AGM 21511566

SX 5 FUNZIONI (POS/STOP/DIR/LT/RN)

RADEX 5800

220x140x60 - INTERASSE FORI 70



AGM 21511567

DX 5 FUNZIONI (POS/STOP/DIR/LT/RM)

RADEX 5800

220x140x60 - INTERASSE FORI 70



AGM 21511699

DX 5 FUNZIONI (POS,STOP,DIR,LT,RN)

RADEX 6400

200X140X52 - INTERASSE FORI 152



AGM 21511700

DX 5 FUNZIONI (POS,STOP,DIR,LT,RM)

RADEX 6400

200X140X52 - interasse fori 152



AGM 21511701

SX 5 FUNZIONI (POS,STOP,DIR,LT,RN)

RADEX 6400

200X140X52 - INTERASSE FORI 152



AGM 21511574

DX 4 FUNZIONI (POS/STOP/DIR/RN)

RADEX 6800

220X160X65 - INTERASSE FORI 70



AGM 21511575

DX 4 FUNZIONI (POS/STOP/DIR/RM)

RADEX 6800

220X160X65 - INTERASSE FORI 70



AGM 21511576

SX 4 FUNZIONI (POS/STOP/DIR/RN)

RADEX 6800

220X160X65 - INTERASSE FORI 70



AGM 21511579

DX 3 FUNZIONI (POS,STOP,DIR)

VERALUX

160X70X70 - INTERASSE PERNI 58



AGM 21511580

SX 4 FUNZIONI (POS,STOP,DIR,LT)

VERALUX

160X70X70 - INTERASSE PERNI 58



AGM 21511581

DX/SX 3 FUNZIONI (POS,STOP,DIR)

VERALUX

110X80X51 - INTERASSE FORI 55



AGM 21511582

DX/SX 4 FUNZIONI (POS,STOP,DIR,LT)

VERALUX

110X80X51 - INTERASSE FORI 55



AGM 21522139

SX 5 FUNZIONI (POS,STOP,DIR,LT,RN)

AJBA FP 40

217X138X55 - INTERASSE FORI 151



AGM 21522132

DX 5 FUNZIONI (POS,STOP,DIR,LT,RM)

AJBA FP 40

217X138X55 - INTERASSE FORI 151



AGM 21522268

SX 5 FUNZIONI (POS,STOP,DIR,LT,RN)

AJBA FP 80

237X138X55 - INTERASSE FORI 151



AGM 21522269

DX 5 FUNZIONI (POS,STOP,DIR,LT,RM)

AJBA FP 80

237X138X55 - INTERASSE FORI 151



AGM 21522128

FANALE POST. SX C/RN

AJBA FP 73

160X220X55 - INTERASSE 110



AGM 21522129

FANALE POST. DX C/RM

AJBA FP 73

160X220X55 - INTERASSE 110



AGM 21522300

SX 4 FUNZIONI (POS,STOP,DIR,RN)

ASPOCK EARLPOINT III

219X146X53 - INTERASSE FORI 150



AGM 21522301

DX 4 FUNZIONI (POS,STOP,DIR,RM)

ASPOCK EARLPOINT III

219X146X53 - INTERASSE FORI 150



AGM 21522296

DX 5 FUNZIONI (POS,STOP,DIR,LT,RM)

ASPOCK MIDIPPOINT II

218X98X57 - INTERASSE FORI 151



AGM 21522297

SX 5 FUNZIONI (POS,STOP,DIR,LT,RN)

ASPOCK MIDIPPOINT II

218X98X57 - INTERASSE FORI 151



AGM 21522294

DX 5 FUNZIONI (POS,STOP,DIR,LT,RM)

ASPOCK MULTIPOINT I

240X140X52 - INTERASSE FORI 152



AGM 21522273

SX 5 FUNZIONI (POS,STOP,DIR,LT,RN)

ASPOCK MULTIPOINT I

240X140X52 - INTERASSE FORI 152

FANALI POSTERIORI CON CONNETTORI



AGM 21522302

DX/SX 4 FUNZIONI (POS,STOP,DIR,LT)

ASPOCK MINIPPOINT

90X95X50 - INTERASSE FORI 45



AGM 21521892

DX 5 FUNZIONI (POS,STOP,DIR,LT,RM)

ASPOCK MULTIPOINT II

240X140X52 - INTERASSE FORI 152



AGM 21521893

SX 5 FUNZIONI (POS,STOP,DIR,LT,RN)

ASPOCK MULTIPOINT II

240X140X52 - INTERASSE FORI 152



AGM 21521894

DX 5 FUNZIONI (POS,STOP,DIR,LT,RM)

ASPOCK MULTIPOINT IV

200X140X56 - INTERASSE FORI 152



AGM 21521895

SX 5 FUNZIONI (POS,STOP,DIR,LT,RN)

ASPOCK MULTIPOINT IV

200X140X56 - INTERASSE FORI 152



AGM 21522270

DX 5 FUNZIONI (POS,STOP,DIR,LT,RM)

ASPOCK MULTIPOINT V

238X140X55 - INTERASSE FORI 152



AGM 21522271

SX 5 FUNZIONI (POS,STOP,DIR,LT,RN)

ASPOCK MULTIPOINT V

238X140X55 - INTERASSE FORI 152



AGM 50542303

MULTIPOINT V LED - FANALE POST. DX
5 FUNZIONI (POS, STOP, DIR, LT, RM)

235X135X60 - INTERASSE FORI 151

ASPOCK MULTIPOINT V - 12/24V



AGM 50542304

MULTIPOINT V LED - FANALE POST. SX
5 FUNZIONI (POS, STOP, DIR, LT, RN)

235X135X60 - INTERASSE FORI 151

ASPOCK MULTIPOINT V - 12/24V



AGM 21531597

DX/SX 3 FUNZIONI (POS,STOP,DIR)

ELLEBI 297510009



AGM 21531598

DX 4 FUNZIONI (POS,STOP,DIR,LT)

ELLEBI 297701005



AGM 21531599

SX 4 FUNZIONI (POS,STOP,DIR,LT)

ELLEBI 297701006



AGM 21531600

MULTIF.DX CON L.TARGA

ELLEBI 297757002



AGM 21531601

MULTIF.SX CON L.TARGA

ELLEBI 297757003



AGM 21521583

DX 5 FUNZIONI (POS/STOP/DIR/LT/RN)

RADEX 2800

220X140X52 - INTERASSE FORI 152



AGM 21521584

DX 5 FUNZIONI (POS/STOP/DIR/LT/RM)

RADEX 2800

220X140X52 - INTERASSE FORI 152



AGM 21521585

SX 5 FUNZIONI (POS/STOP/DIR/LT/RN)

RADEX 2800

220X140X52 - INTERASSE FORI 152



AGM 21521586

DX 5 FUNZIONI (POS/STOP/DIR/LT/RN)

RADEX 2900

180X240X60 - INTERASSE FORI 130



AGM 21521587

DX 5 FUNZIONI (POS/STOP/DIR/LT/RM)

RADEX 2900

180X240X60 - INTERASSE FORI 130



AGM 21521588

SX 5 FUNZIONI (POS/STOP/DIR/LT/RN)

RADEX 2900

180X240X60 - INTERASSE FORI 130



AGM 21521589

DX 5 FUNZIONI (POS/STOP/DIR/LT/RN)

RADEX 5900

220X140X60 - INTERASSE FORI 152



AGM 21521590

DX 5 FUNZIONI (POS/STOP/DIR/LT/RM)

RADEX 5900

220X140X60 - INTERASSE FORI 152



AGM 21521591

SX 5 FUNZIONI (POS/STOP/DIR/LT/RN)

RADEX 5900

220X140X60 - INTERASSE FORI 152



AGM 21521592

DX 4 FUNZIONI (POS/STOP/DIR/RN)

RADEX 5900

220X140X60 - INTERASSE FORI 152



AGM 21521593

SX 4 FUNZIONI (POS/STOP/DIR/RN)

RADEX 5900

220X140X60 - INTERASSE FORI 152



AGM 21521702

DX 5 FUNZIONI (POS,STOP,DIR,LT,RN)

RADEX 6400

200X140X52 - INTERASSE FORI 152



AGM 21521703

DX 5 FUNZIONI (POS,STOP,DIR,LT,RM)

RADEX 6400

200X140X52 - INTERASSE FORI 152



AGM 21521704

SX 5 FUNZIONI (POS,STOP,DIR,LT,RN)

RADEX 6400

200X140X52 - INTERASSE FORI 152



AGM 21522009

SX 5 FUNZIONI (POS,STOP,DIR,LT,RN)

RADEX 6400/SM

220X118X52 - INTERASSE FORI 152



AGM 21522087

DX 5 FUNZIONI (POS/STOP/DIR/LT/RN)

RADEX 6400/SM

220X118X52 - INTERASSE FORI 152



AGM 21522089

DX 5 FUNZIONI (POS/STOP/DIR/LT/RM)

RADEX 6400/SM

220X118X52 - INTERASSE FORI 152



AGM 21521594

DX 4 FUNZIONI (POS/STOP/DIR/RN)

RADEX 6800

160X220X65 - INTERASSE FORI 70



AGM 21521595

DX 4 FUNZIONI (POS/STOP/DIR/RM)

RADEX 6800

160X220X65 - INTERASSE FORI 70



AGM 21521596

SX 4 FUNZIONI (POS/STOP/DIR/RN)

RADEX 6800

160X220X65 - INTERASSE FORI 70



AGM 21522274

DX 4 FUNZIONI (POS,STOP,DIR,RM)

HUMBAUR



AGM 21522275

SX 4 FUNZIONI (POS,STOP,DIR,RN)

HUMBAUR



AGM 50622274

**KIT FANALI POST. C/MAGNETI
WIRELESS (BLUETOOTH) SPINA 7 POLI**

AGM 50622275

**KIT FANALI POST. C/MAGNETI
WIRELESS (BLUETOOTH) SPINA 13 POLI**



AGM 50622088

KIT FANALI POST. C/MAGNETI

CAVO 7,5+2,5 MT



AGM 50622492

KIT LUCI RADEX 5600



AGM 50621983

KIT LUCI PER RIMORCHI FINO A KG. 600
Cavo centrale: 2,95 mt 7x0,50

Spina: 7 poli in plastica



AGM 50621985

KIT LUCI PER RIMORCHI FINO A KG. 600
Cavo centrale: 7 mt 5x0,50

Spina: 7 poli in plastica



AGM 50621986

KIT LUCI PER RIMORCHI
Cavo centrale: 2,4 mt 7x0,50

Spina: 7 poli in plastica



AGM 50621779

BARRA REGOLABILE MT. 1,10/1,70

AGM 50621780

BARRA REGOLABILE MT. 1,80/3,00

CAVO MT. 7 - SPINA 7 POLI - CATARIFRANGENTI TRIANGOLARI

FANALE SX 4 FUNZIONI (POS,STOP,DIR,LT) - FANALE DX 3 FUNZIONI (POS,STOP,DIR)



AGM 50621888

DIM: CM. 180X15

PRESA 13 POLI - LUCI INGOMBRO LATERALI

FANALE SX 5 FUNZIONI (POS,STOP,DIR, LT,RN) - FANALE DX 5 FUNZIONI (POS,STOP,DIR,LT,RM)



AGM 21551976

AJBA VETROFANALE SX/DX
FP 40

217x138



AGM 21552112

AJBA VETROFANALE SX
FP 80

237x138



AGM 21552114

AJBA VETROFANALE DX
FP 80

237x138



AGM 21551603

VETROFANALE SX CON LUCE TARGA



AGM 21551602

RADEX VETROFANALE DX SENZA LUCE
TARGA



AGM 21551605

RADEX 5001 VETROFANALE DX



AGM 21551606

RADEX 5001 VETROFANALE SX

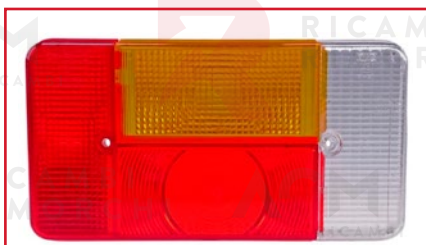

AGM 21551607

RADEX 5001 VETROFANALE DX CON
RETROMARCIA



AGM 21551608

RADEX 2800 VETROFANALE DX



AGM 21551609

RADEX 2800 VETROFANALE DX CON
RETROMARCIA

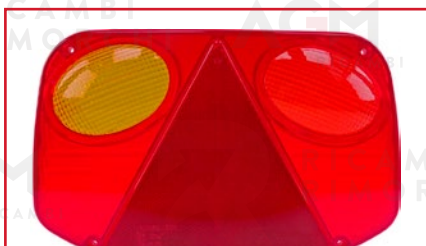

AGM 21551610

RADEX 2800 VETROFANALE SX



AGM 21551611

RADEX 2900 VETROFANALE DX



AGM 2155162

RADEX 2900 VETROFANALE DX CON
RETROMARCIA



AGM 2155163

RADEX 2900 VETROFANALE SX



AGM 2155164

RADEX 5900 VETROFANALE DX



AGM 2155165

RADEX 5900 VETROFANALE DX CON
RETROMARCIA



AGM 2155166

RADEX 5900 VETROFANALE SX

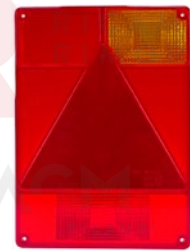

AGM 2155167

RADEX 6800 VETROFANALE DX



AGM 2155168

RADEX 6800 VETROFANALE DX CON
RETROMARCIA

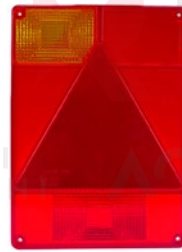

AGM 2155169

RADEX 6800 VETROFANALE SX



AGM 21551705

RADEX 6400 VETROFANALE DX



AGM 21551706

RADEX 6400 VETROFANALE DX CON
RETROMARCIA



AGM 21551707

RADEX 6400 VETROFANALE SX



AGM 21551604

VETROFANALE DX/SX



AGM 21552352

RADEX 5600 VETROFANALE DX
CON RETROMARCIA



AGM 21552351

RADEX 5600 VETROFANALE SX



AGM 21551194

MULTIPOINT II VETROFANALE SX/DX



AGM 50552487

MULTIPOINT IV VETROFANALE DX C/RN



AGM 50552488

MULTIPOINT IV VETROFANALE SX C/RN



AGM 21552140

AJBA VETROFANALE SX
FP 70

160x220



AGM 21552141

AJBA VETROFANALE DX
FP 70

160x220



AGM 50561620

BIANCO/ROSSO BASE PIANA - 12V

41X90X41



AGM 50561621

BIANCO/ROSSO BASE IN GOMMA - 12V

45X116X45 - interasse fori 15



AGM 50561624

ROSSO CON SUPPORTO - 12V

97X90X45



AGM 50561625

OBLIQUO BIANCO/ROSSO - 12V

100X190X76



AGM 50561626

INCLINATO 90° BIANCO/ROSSO - 12V

100X155X76



AGM 50561774

BIANCO/ROSSO BASE PIANA - 12V

65X42X30



AGM 50561775

BIANCO/ROSSO CON SUPPORTO - 12V

95X65X33



AGM 50561776

BIANCO/ROSSO CON SUPPORTO - 12V

113X42X34



AGM 50561777

BIANCO/ROSSO BASE PIANA - 12V

96X42X33



AGM 50561778

BIANCO/ROSSO CON SUPPORTO - 12V

140X65X34

FANALI DI POSIZIONE LATERALI



AGM 50561627

ARANCIO - 12V

112X41X24 - interasse fori 45



AGM 50561629

ARANCIO - 12V

62X65X40 - interasse fori 30



AGM 50561769

ARANCIO - 12V

65X42X30



AGM 50561770

ARANCIO CON SUPPORTO - 12V

95X65X33



AGM 50561771

ARANCIO CON SUPPORTO - 12V

113X42X34



AGM 50561772

ARANCIO - 12V

96X42X33



AGM 50561773

ARANCIO CON SUPPORTO - 12V

140X65X34



AGM 50561628

SUPPORTO PER FANALE 50561627

Interasse fori 19-48



AGM 50561622

BIANCO - 12V

62X65X40 - interasse fori 30



AGM 50561623

BIANCO - 12V CON SUPPORTO

63X119X47 - interasse fori 32



AGM 50561764

BIANCO - 12V

65X42X30



AGM 50561765

BIANCO CON SUPPORTO - 12V

95X65X33



AGM 50561766

BIANCO CON SUPPORTO - 12V

113X42X34



AGM 50561767

BIANCO - 12V

96X42X33



AGM 50561768

BIANCO CON SUPPORTO - 12V

140X65X34



AGM 50542290

RETRONEBBIA

Ø 140X29

LED 20 - 12/24V



AGM 50542291

RETROMARCIA

Ø 140X29

LED 20 - 12/24V



AGM 50542306

RETROMARCIA

99X93X30 - INTERASSE FORI 45

LED 12 - 12/24V



AGM 50572319

LED 12/24V

83X40X30



AGM 50591630

FANALE LUCE TARGA

30X80X34



AGM 50591631

FANALE LUCE TARGA

30X90X45



AGM 50591632

FANALE LUCE TARGA

100X47X60



AGM 50752307

LAMPADINA 21W/12V
Confezione 10 pz

IND. DIR./RETRONEBBIA



AGM 50752308

LAMPADINA 5-21W/12V
Confezione 10 pz

POSIZ./STOP



AGM 50752309

LAMPADINA 5W/12V
Confezione 10 pz

POSIZ./TARGA



AGM 50752310

LAMPADINA 5W/12V
Confezione 10 pz

POSIZ./TARGA



AGM 50601633

RETT. ROSSO ADESIVO

mm. 90X40



AGM 50601634

RETT. ARANCIO ADESIVO

mm. 90X40

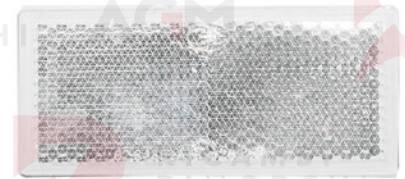

AGM 50601635

RETT. BIANCO ADESIVO

mm. 90X40



AGM 50602079

TONDO Ø 60 ARANCIO

foro Ø mm. 5



AGM 50602080

TONDO Ø 60 ROSSO

foro Ø mm. 5



AGM 50602081

TONDO Ø 60 BIANCO

foro Ø mm. 5



AGM 50602082

TONDO ROSSO ADESIVO

Ø mm. 60



AGM 50602083

TONDO BIANCO ADESIVO

Ø mm. 60



AGM 50602093

TONDO ARANCIO ADESIVO

Ø mm. 60



AGM 50601636

TONDO CON VITE BIANCO

Ø mm. 60



AGM 50601637

TONDO CON VITE ROSSO

Ø mm. 60



AGM 50601638

TONDO CON VITE ARANCIO

Ø mm. 60



AGM 50601639

TRIANGOLARE ROSSO C/VITI DI FISSAGGIO M5

162X142 - Interasse fori 70



AGM 50602322

TRIANGOLARE ROSSO fori mm. 5

152X136 - Interasse fori 70

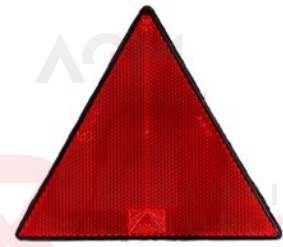

AGM 50602084

CATADIOTTO TRIANGOLARE ADESIVO

155x136



AGM 50711650

DISCO LIMITE DI VELOCITA' 70 KM/H

Ø mm. 200



AGM 50711651

DISCO LIMITE DI VELOCITA' 80 KM/H

Ø mm. 200

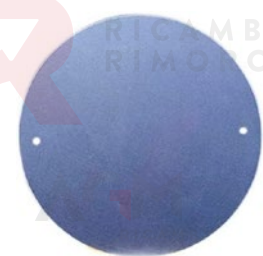

AGM 50711652

SUPPORTO IN ALLUMINIO

Ø mm. 200x1

LETTERE E NUMERI ADESIVI mm. 40x80 - PER TARGHE RIPETITRICI

ABCDEFGHI
KLMNOPQRSTU
VZXYWJ

012345
6789

AGM 50721653	LETTERA A	AGM 50721676	LETTERA O
AGM 50721654	LETTERA B	AGM 50721677	LETTERA P
AGM 50721655	LETTERA C	AGM 50721678	LETTERA Q
AGM 50721656	LETTERA D	AGM 50721679	LETTERA R
AGM 50721657	LETTERA E	AGM 50721680	LETTERA S
AGM 50721658	LETTERA F	AGM 50721681	LETTERA T
AGM 50721659	LETTERA G	AGM 50721682	LETTERA U
AGM 50721670	LETTERA H	AGM 50721683	LETTERA V
AGM 50721671	LETTERA I	AGM 50721684	LETTERA Z
AGM 50721672	LETTERA K	AGM 50721685	LETTERA X
AGM 50721673	LETTERA L	AGM 50721686	LETTERA Y
AGM 50721674	LETTERA M	AGM 50721687	LETTERA W
AGM 50721675	LETTERA N	AGM 50721688	LETTERA J

AGM 50721660	NUMERO 0
AGM 50721661	NUMERO 1
AGM 50721662	NUMERO 2
AGM 50721663	NUMERO 3
AGM 50721664	NUMERO 4
AGM 50721665	NUMERO 5
AGM 50721666	NUMERO 6
AGM 50721667	NUMERO 7
AGM 50721668	NUMERO 8
AGM 50721669	NUMERO 9



AGM 50612328

CAVO PROLUNGA MT. 5

SPINA E PRESA 7 POLI



AGM 50612329

CAVO PROLUNGA MT. 5

SPINA E PRESA 13 POLI



AGM 50612331

CAVO PROLUNGA MT. 5

2 SPINE 7 POLI



AGM 50612332

CAVO PROLUNGA MT. 7

2 SPINE 7 POLI



AGM 50612071

CAVO PROLUNGA MT. 10

2 SPINE 7 POLI



AGM 50612325

KIT PRESA PRECABLATA 7 P

CAVO MT. 1,5



AGM 50612326

KIT PRESA PRECABLATA 13 P

CAVO MT. 1,5



AGM 50612515

KIT CONNETTORI DX/SX ASPOCK



AGM 50612293

KIT CONNETTORE A 5 POLI



AGM 50612286

CONNETTORE VERDE A 5 POLI ASPOCK

CAVO MT. 1



AGM 50612285

CONNETTORE GIALLO A 5 POLI ASPOCK

CAVO MT. 1



AGM 50612339

KIT PRESA E SPINA 7 POLI PLASTICA

BASE PRESA OVALE



AGM 50612340

KIT PRESA E SPINA 13 POLI PLASTICA

BASE PRESA OVALE



AGM 50612341

KIT PRESA E SPINA 7 POLI METALLO

BASE PRESA TONDA



AGM 50612342

KIT PRESA E SPINA 7 POLI PLASTICA

BASE PRESA TONDA



AGM 50611640

PRESA IN PLASTICA 7 POLI 12V

BASE OVALE



AGM 50612333

PRESA IN PLASTICA 7 POLI 12V

BASE TONDA



AGM 50611641

PRESA IN PLASTICA 13/13 POLI 12V

BASE OVALE



AGM 50611642

PRESA IN METALLO 7 POLI 12V

BASE TONDA



AGM 50612322

KIT PRESA IN PLASTICA 7 POLI 12V

PRESA + GUARN. BASE OVALE



AGM 50612323

KIT PRESA IN PLASTICA 13/13 POLI 12V

PRESA + GUARN. BASE OVALE



AGM 50612324

KIT PRESA IN METALLO 7 POLI 12V

PRESA + GUARN. BASE OVALE



AGM 50611643

GUARNIZIONE PER PRESA OVALE



AGM 50611204

GUARNIZIONE PER PRESA TONDA



AGM 50611644

SPINA IN PLASTICA 7 POLI 12V CON DADO



AGM 50611645

SPINA IN PLASTICA 13 POLI 12V CON DADO



AGM 50611646

SPINA IN METALLO 7 POLI 12V CON DADO



AGM 50611647

ADATTATORE IN PLASTICA 13/7 POLI 12V

SPINA 7 POLI - PRESA 13 POLI



AGM 50611648

ADATTATORE IN PLASTICA 7/13 POLI 12V

SPINA 13 POLI - PRESA 7 POLI



AGM 10612035

PORTASPINA ROSSO GIREVOLE 13/7 POLI

AL-KO 2182600004



AGM 50612334

PORTASPINA BLU GIREVOLE 13/7 POLI

CHIUSURE / CERNIERE



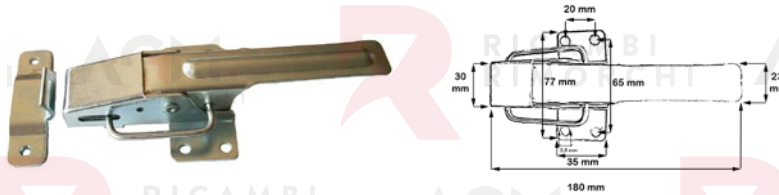

AGM 50811689

CHIUSURA C/RISCONTRO PIEGATO IN FERRO ZN

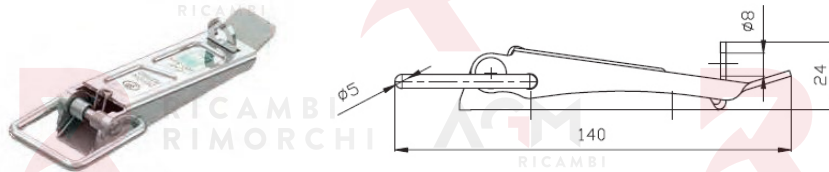

AGM 50811691

CHIUSURA C/LUCCHETTO C/RISCONTRO

KG. 600 - RISCONTRO MM. 65X26

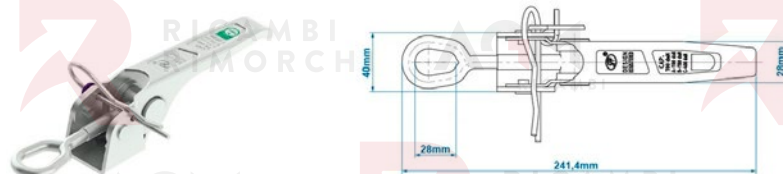

AGM 50811692

CHIUSURA IN FERRO ZINCATA ZB-03

KG. 700



AGM 50811693

RISCONTRO Z-03 PER CHIUSURA

KG. 650 - MM. 140X30



AGM 50812343

GANCIO AD ANELLO mm. 105X105

RICAMBI
RIMORCHI

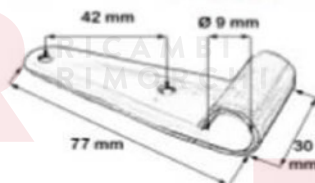
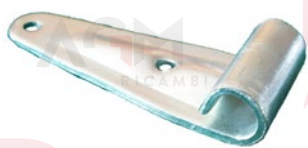

AGM 50811694

CERNIERA PIATTA CON FORI ZINCATA

RICAMBI
RIMORCHI

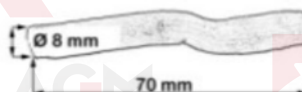

AGM 50811695

PERNO PER CERNIERA IN LAMIERA

RICAMBI
RIMORCHI

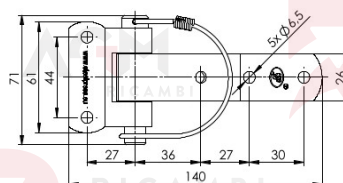

AGM 50811696

CERNIERA PIEGATA APRIBILE IN FERRO ZN

RICAMBI
RIMORCHI

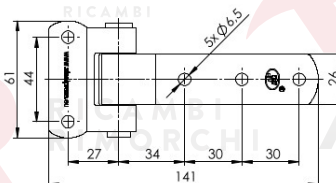

AGM 50811697

CERNIERA LUNGA FISSA IN FERRO ZN

RICAMBI
RIMORCHI

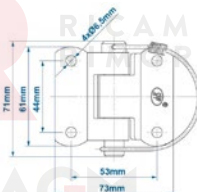

AGM 50811698

CERNIERA CORTA APRIBILE IN FERRO ZN

RICAMBI
RIMORCHI

RICAMBI
RIMORCHI

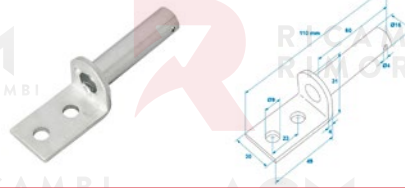

AGM 50812254

CERNIERA

RICAMBI
RIMORCHI

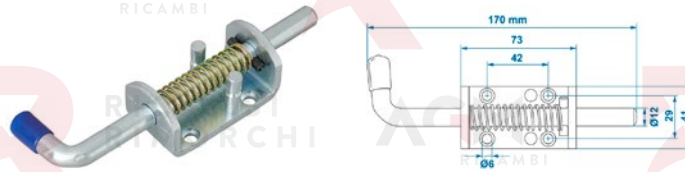

AGM 50812255

CHIUSURA A MOLLA

RICAMBI
RIMORCHI

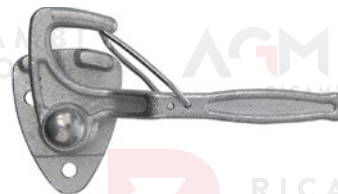

AGM 50812256

CHIUSURA CON MOLLA SX MM. 140

RICAMBI
RIMORCHI

RICAMBI
RIMORCHI



AGM 50812152

RISCONTRO PER 50812256/50812153 MM. 125

RICAMBI
RIMORCHI

RICAMBI
RIMORCHI

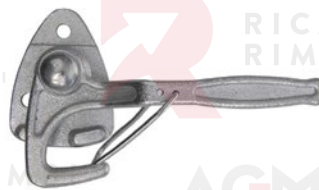

AGM 50812153

CHIUSURA CON MOLLA DX MM. 140

RICAMBI
RIMORCHI

RICAMBI
RIMORCHI

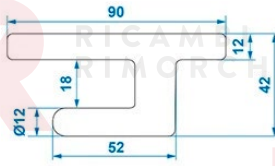

AGM 50812112

CERNIERA ELLEBI

RICAMBI
RIMORCHI

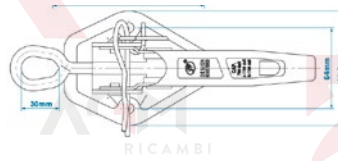

AGM 50812154

CHIUSURA

KG. 1100



AGM 50812257

CAPPUCCIO TERMINALE Q. 30X30H20

Confezione 10 pz

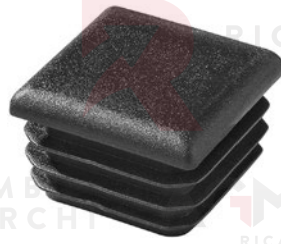

AGM 50812258

CAPPUCCIO TERMINALE Q. 40X40H20

Confezione 10 pz

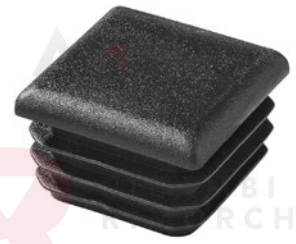

AGM 50812259

CAPPUCCIO TERMINALE Q. 50X50H20

Confezione 10 pz

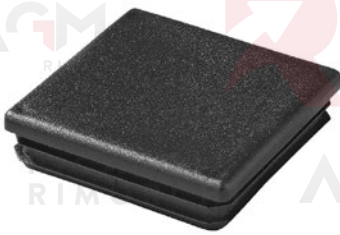

AGM 50812260

CAPPUCCIO TERMINALE Q. 60X60H16

Confezione 10 pz



AGM 50812261

CAPPUCCIO TERMINALE T. 30XH16

Confezione 10 pz



AGM 50812262

CAPPUCCIO TERMINALE T. 40XH20

Confezione 10 pz



AGM 50812263

CAPPUCCIO TERMINALE T. 50XH20

Confezione 10 pz



AGM 50812264

CAPPUCCIO TERMINALE T. 60XH20

Confezione 10 pz

AL-KO

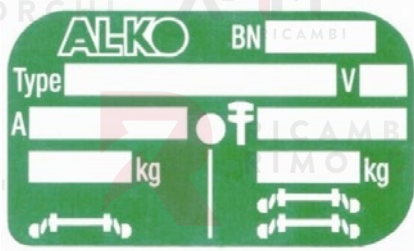

AL-KO Targhetta assale



AXF / GSM

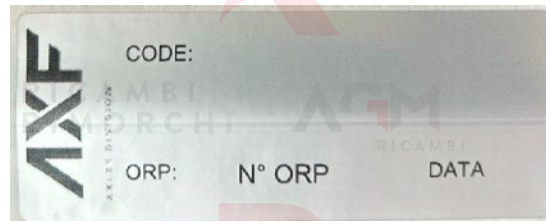

BPW

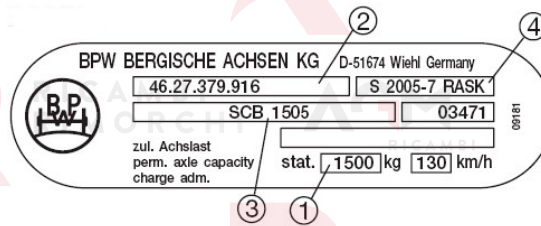

ELLEBI

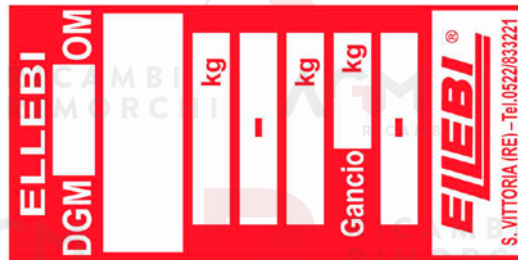

KNOTT



OMC



AL-KO

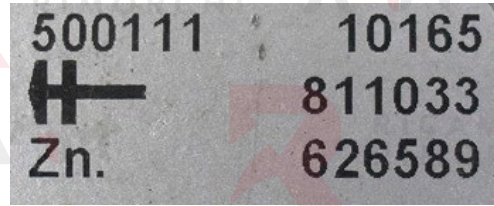
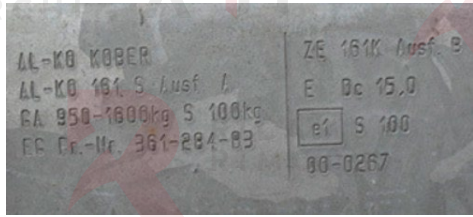

AXF / GSM

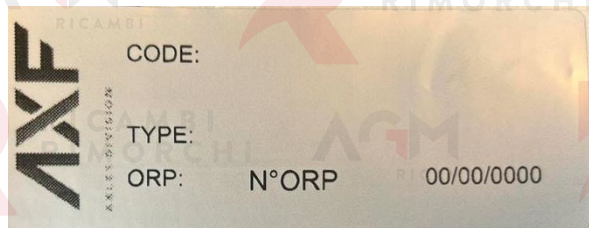

BPW

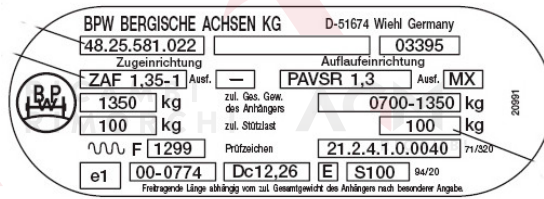

ELLEBI

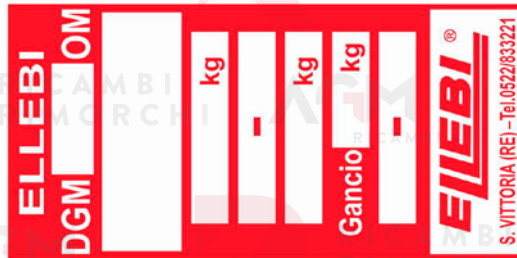

KNOTT

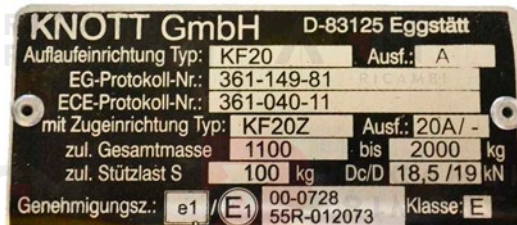

OMC

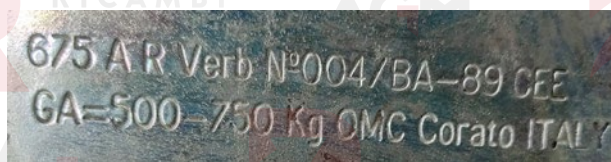

CONDIZIONI GENERALI DI VENDITA

Le presenti Condizioni Generali di vendita regolano tutti i contratti stipulati da Agm Ricambi Srl con terzi per la vendita dei propri prodotti. Tali condizioni fanno parte integrante e sostanziale di ogni proposta e conferma d'ordine stipulata da Agm Ricambi Srl. Ogni ordine sarà regolato in base alle condizioni di vendita in vigore alla data dell'ordine stesso.

CONDIZIONI GENERALI

Le Condizioni Generali potranno essere modificate e/o aggiornate da Agm Ricambi Srl, anche in base ad eventuali cambiamenti normativi.

CARATTERISTICHE DEI PRODOTTI E DOCUMENTI DESCRITTIVO-ILLUSTRATIVI

Le caratteristiche e/o specifiche tecniche, i colori, le immagini, le informazioni descrittive dei prodotti riportati su qualsiasi supporto incluso il sito web, hanno puro valore indicativo e non sono vincolanti per Agm Ricambi Srl.

ORDINE

Al fine di evitare malintesi, essi dovranno menzionare:

codice Cliente, codice articolo, descrizione dello stesso, colore e dimensione, dove necessario.

Gli ordini saranno evasi secondo la disponibilità del momento; eventuali rimanenze verranno spedite, salvo ordine contrario, appena possibile in porto assegnato od unitamente ad un nuovo ordine.

Il Cliente nell'inviare l'ordine, dichiara di accettare implicitamente le presenti condizioni di vendita.

PREZZI

I prezzi indicati si intendono franco magazzino Agm Ricambi Srl al netto di imposte, imballo, trasporto, assicurazione, eventuali oneri doganali, fiscali e tutto quanto non espressamente menzionato.

I prezzi sono aggiornati periodicamente e sono pubblicati su www.agmricambi.it.

Agm Ricambi Srl si riserva la facoltà di apportare variazioni ai prezzi di listino senza preavviso. È premura del Cliente richiedere la versione aggiornata del listino in vigore.

MODALITÀ DI PAGAMENTO

I pagamenti devono essere effettuati a Agm Ricambi Srl alla scadenza stabilita e per l'importo pattuito. Le condizioni di pagamento devono essere concordate con l'Ufficio vendite. Il ritardo del pagamento delle fatture oltre i termini concordati dà luogo all'immediata decorrenza degli interessi commerciali bancari e comporta la conseguente sospensione delle forniture in corso o future. Il mancato pagamento anche di una sola rata della fattura comporterà la decadenza dal beneficio del termine pur non ricorrendo gli estremi di cui all'art. 1186 cod.civ.

RESI MERCE

I resi merce devono essere tassativamente autorizzati. Qualsiasi spedizione non autorizzata verrà respinta. È possibile effettuare resi entro e non oltre 20 giorni dalla data fattura, o comunque non oltre i termini previsti dalla Legge. La spedizione dovrà essere effettuata in porto franco, se concordato preventivamente potranno essere accettate spedizioni in porto assegnato ma con addebito sulla successiva fattura. Il DDT di reso dovrà pervenire completo di numero e data del DDT o fattura di acquisto e del numero di rientro assegnatoVi. Tale mancanza sarà motivo di non accettazione del reso.

La merce resa dovrà essere esattamente nello stato di conservazione in cui è pervenuta all'acquirente. Diversamente verrà restituita. A titolo di rimborso per le spese di movimentazione verrà addebitato il 20% del valore con un minimo di euro 20,00 fatti salvi maggiori oneri dell'eventuale ripristino, che saranno conteggiati al costo. La nota di credito, quando dovuta, potrà essere rilasciata entro 12 mesi dalla data fattura.

RESI DI PRODOTTI DIFETTOSI

Si garantisce che il prodotto fornito è esente da vizi ai fini di un uso normale per un periodo di un anno dalla data di spedizione. Entro tale periodo saranno sostituiti tutti i pezzi da Agm Ricambi Srl riconosciuti difettosi per cause dipendenti dal materiale o dalla lavorazione, purché non siano stati modificati. La ns. responsabilità resta in ogni caso limitata strettamente alla sostituzione dei pezzi difettosi, declinando ogni responsabilità per qualunque conseguenza o danno derivante dalla merce fornita, compresa la mano d'opera per operazioni di smontaggio e montaggio e per l'eventuale acquisto di parti complementari. La garanzia non comprende la manodopera necessaria alla sostituzione dei materiali, trasferte o trasporti. Non è ammesso nessun rimborso per spese accessorie sostenute o per l'immobilizzo del rimorchio o altre spese. Ogni diversa garanzia, anche di legge deve ritenersi esclusa e superata dalle presenti condizioni. L'acquirente rinuncia ad avvalersi del diritto di recesso.

TERMINI DI CONSEGNA E SPEDIZIONE

La merce viaggia a rischio e pericolo del committente anche se spedite in porto franco. Tutte le spedizioni, se non espressamente precisato il mezzo di trasporto, verranno effettuate con il corriere ritenuto più opportuno da Agm Ricambi Srl. Eventuali ritardi nelle consegne non potranno giustificare richieste di rimborso o pagamenti di danni. Eventuali reclami sulla merce saranno accettati solo se presentati entro 8 giorni dal ricevimento. I termini di consegna avranno valore puramente indicativo e eventuali ritardi nella consegna dei Prodotti non potranno comportare in ogni caso alcuna responsabilità o risarcimento di danni in capo a Agm ricambi Srl.

LEGGE APPLICABILE E FORO COMPETENTE

Il rapporto di compravendita è regolato esclusivamente dalla Legge Italiana, in caso di controversie che non trovassero una soluzione concordata sarà competente il foro di Firenze per le vendite effettuate da Agm Ricambi Srl.

Agm Ricambi Srl declina ogni responsabilità per le possibili inesattezze contenute nel presente catalogo, dovute ad eventuali errori di stampa o di trascrizione; si riserva il diritto di apportare ai propri articoli quelle modifiche che riterrà necessarie o utili senza pregiudicarne le caratteristiche essenziali. Le foto dei prodotti e le loro informazioni tecniche ed estetiche nonché i loro colori sono puramente dimostrative e non vincolanti e non potranno in nessun caso essere utilizzate per possibili reclami.

La direzione commerciale di Agm Ricambi Srl si riserva tramite lettera sottoscritta di autorizzare l'uso e la pubblicazione di materiale fotografico di sua proprietà.

I diritti di pubblicazione di questo catalogo e del suo relativo listino sono di proprietà di Agm Ricambi Srl e ne è vietata qualsiasi riproduzione anche parziale senza il suo consenso scritto.

Regolamento Europeo n° 679/2016

relativo alla protezione delle persone fisiche con riguardo al trattamento dei dati personali ed alla libera circolazione di tali dati.

Informativa ex art 13 e 14 del regolamento

Desideriamo informarLa, in ossequio al regolamento Europeo n° 679/2016 che prevede norme a tutela delle persone e di altri soggetti rispetto al trattamento dei dati personali, di quanto di seguito specificato.

Secondo la normativa indicata, il trattamento dei suoi dati personali, sarà improntato ai principi di correttezza, liceità e trasparenza e di tutela della Sua riservatezza e dei Suoi diritti.

Ai sensi dell'articolo 13 e 14 del suddetto regolamento pertanto, Le forniamo le seguenti informazioni:

- I dati da Lei forniti, saranno trattati per le finalità inerenti la corretta gestione dei rapporti (sia di natura legale che contrattuale) in essere con Agm Ricambi Srl e per il periodo di tempo strettamente necessario alla gestione del rapporto instaurato, periodo che tuttavia non è preventivabile a priori, potendosi comunque fare riferimento quale criterio generale alle previsioni di legge in materia di prescrizione.

- I dati forniti NON saranno oggetto di attività di profilazione né tantomeno di processi decisionali automatizzati e quindi in sostanza non saranno utilizzati per poter trarre dagli stessi, informazioni relative alla propria situazione economica, ai propri interessi, alla propria salute, ecc.

- Il trattamento dei dati, potrà essere effettuato con modalità manuali, informatiche o elettroniche sempre con la garanzia della sicurezza e della riservatezza degli stessi.

- Il conferimento dei dati è obbligatorio per le finalità di cui al punto 1, l'eventuale rifiuto di fornire tali dati potrebbe a seconda dei casi comportare l'impossibilità totale o parziale di esecuzione del contratto o comunque del rapporto.

- I dati potranno essere comunicati ad altri soggetti, così come essere oggetto di diffusione, esclusivamente per il raggiungimento delle finalità di cui al punto 1. In questo senso, a puro titolo di esempio, potranno essere comunicati all'amministrazione finanziaria, ad enti previdenziali ed assistenziali, così come ai nostri consulenti o collaboratori esterni.

- I dati potranno essere, ai sensi della lettera f dell'art. 13 del regolamento, trasferiti a paesi terzi o organizzazioni internazionali rispetto alle quali sarà preventivamente verificato il ricorrere o meno dell'esistenza di una decisione di adeguatezza da parte della commissione, potendo in mancanza della predetta decisione di adeguatezza, procedere al trasferimento dei dati nel rispetto delle previsioni di cui agli artt. 46 e 47, oppure in subordine nel rispetto di quanto previsto dall'art. 49 lettere da "a" a "g".

- Il titolare del trattamento è: Agm Ricambi Srl in persona del suo legale rappresentante contattabile al numero telefonico 055 8874780, email amministrazione@agmr.it.

- In ogni momento potrà esercitare inviando una comunicazione via e-mail al soggetto di cui al punto 7 i suoi diritti per come definiti nel regolamento 679/2016 (artt. da 15 a 22), più in particolare:

- avrà il diritto di chiedere l'accesso ai dati personali e la rettifica o la cancellazione degli stessi o la limitazione del trattamento, o di opporsi allo stesso trattamento oltre al diritto alla portabilità dei dati medesimi;
- qualora il trattamento sia basato sulle previsioni di cui all'art. 6 paragrafo 1 lettera "a" oppure sulle previsioni di cui all'articolo 9 paragrafo 2 lettera "a", potrà revocare il consenso in qualsiasi momento senza pregiudicare la liceità del trattamento basato sul consenso prestato prima della revoca;
- avrà il diritto di proporre reclamo ad un'autorità di controllo.



Contatti

AGM RICAMBI SRL

rimorchi@agmr.it

tel 055 0981801

www.agmricambi.it